



DataDirect **XML Converters™**

User's Guide and Reference
for .NET

Release 3.1
December 2007

© 2007 Progress Software Corporation. All rights reserved.

Progress® software products are copyrighted and all rights are reserved by Progress Software Corporation. This manual is also copyrighted and all rights are reserved. This manual may not, in whole or in part, be copied, translated, or reduced to any electronic medium or machine-readable form without prior consent, in writing, from Progress Software Corporation.

The information in this manual is subject to change without notice, and Progress Software Corporation assumes no responsibility for any errors that may appear in this document. The references in this manual to specific platforms supported are subject to change.

A (and design), Actional, Actional (and design), Affinities Server, Allegrix, Allegrix (and design), Apama, Business Empowerment, DataDirect (and design), DataDirect Connect, DataDirect Connect64, DataDirect Connect OLE DB, DataDirect Technologies, DataDirect XQuery, DirectAlert, Dynamic Index Utility, Dynamic Routing Architecture, EasyAsk, EdgeXtend, Empowerment Center, eXcelon, Fathom, Halo, IntelliStream, Iwave Integrator, LiveMine, Neon, Neon 24x7, Neon New Era of Networks, Neon Unload, O (and design), ObjectStore, OpenEdge, PDF, PeerDirect, Persistence, Persistence (and design), POSSENET, Powered by Progress, PowerTier, ProCare, Progress, Progress Dynamics, Progress Business Empowerment, Progress Empowerment Center, Progress Empowerment Program, Progress Fast Track, Progress OpenEdge, Progress Profiles, Progress Results, Progress Software Developers Network, ProtoSpeed, ProVision, PS Select, SequeLink, Shadow, ShadowDirect, Shadow Interface, Shadow Web Interface, Shadow Web Server, Shadow TLS, SOAPStation, Sonic ESB, SonicMQ, Sonic Orchestration Server, Sonic Software (and design), SonicSynergy, Speed Load, SpeedScript, Speed Unload, Stylus Studio, Technical Empowerment, UIM/X, Visual Edge, Voice of Experience, WebSpeed, and Your Software, Our Technology-Experience the Connection are registered trademarks of Progress Software Corporation or one of its subsidiaries or affiliates in the U.S. and/or other countries. AccelEvent, A Data Center of Your Very Own, Apama Dashboard Studio, Apama Event Manager, Apama Event Modeler, Apama Event Store, AppsAlive, AppServer, ASPen, ASP-in-a-Box, BusinessEdge, Cache-Forward, Connect Everything, Achieve Anything., DataDirect Spy, DataDirect SupportLink, DataDirect Test, DataDirect XML Converters, DataXtend, Future Proof, Ghost Agents, GVAC, Looking Glass, ObjectCache, ObjectStore Inspector, ObjectStore Performance Expert, Pantero, POSSE, ProDataSet, Progress DataXtend, Progress ESP Event Manager, Progress ESP Event Modeler, Progress Event Engine, Progress RFID, PSE Pro, PS Select, SectorAlliance, SmartBrowser, SmartComponent, SmartDataBrowser, SmartDataObjects, SmartDataView, SmartDialog, SmartFolder, SmartFrame, SmartObjects, SmartPanel, SmartQuery, SmartViewer, SmartWindow, Sonic Business Integration Suite, Sonic Process Manager, Sonic Collaboration Server, Sonic Continuous Availability Architecture, Sonic Database Service, Sonic Workbench, Sonic Orchestration Server, Sonic XML Server, WebClient, and Who Makes Progress are trademarks or service marks of Progress Software Corporation or one of its subsidiaries or affiliates in the U.S. and other countries.

Java and all Java-based marks are trademarks or registered trademarks of Sun Microsystems, Inc. in the U.S. and other countries.

Any other trademarks or service marks contained herein are the property of their respective owners.

Stylus Studio includes:

Xerces c++ developed by the Apache Software Foundation ([http:// www.apache.org/](http://www.apache.org/)). Copyright © 1999-2006 the Apache Software Foundation. All rights reserved.

XercesJ developed by the Apache Software Foundation ([http:// www.apache.org/](http://www.apache.org/)). Copyright © 1999-2006 the Apache Software Foundation. All rights reserved.

FOP developed by the Apache Software Foundation ([http:// www.apache.org/](http://www.apache.org/)). Copyright © 1999-2006 the Apache Software Foundation. All rights reserved.

Axis developed by the Apache Software Foundation ([http:// www.apache.org/](http://www.apache.org/)). Copyright © 1999-2006 the Apache Software Foundation. All rights reserved.

The names "Xalan", "FOP", and "Apache Software Foundation" must not be used to endorse or promote products derived from this software without prior written permission. Products derived from this software may not be called "Apache", nor may "Apache" appear in their name, without prior written permission of the Apache Software Foundation. For written permission, please contact apache@apache.org.

Files that are subject to the DSTC Public License (DPL) Version 1.1 (the "License"); you may not use this file except in compliance with the License. You may obtain a copy of the License at [http:// www.dstc.com](http://www.dstc.com). Software distributed under the License is distributed on an "AS IS" basis, WITHOUT WARRANTY OF ANY KIND, either express or implied. See the License for the specific language governing rights and limitations under the License. The Original Code is xs3p. The Initial Developer of the Original Code is DSTC. Portions created by DSTC are Copyright © 2002. All rights reserved.

Pathan developed by DecisionSoft Limited. Copyright © 2001 DecisionSoft Limited. All rights reserved.

Software developed by Thai Open Source Software Center Ltd. Copyright © 2001-2003, Thai Open Source Software Center Ltd. All rights reserved.

IBM ICU developed by IBM. Copyright © 1995-2003 International Business Machines Corporation and others. All rights reserved. Permission is hereby granted, free of charge, to any person obtaining a copy of this software and associated documentation files (the "Software"), to deal in the Software without restriction, including without limitation the rights to use, copy, modify, merge, publish, distribute, and/or sell copies of the Software, and to permit persons to whom the Software is furnished to do so, provided that the above copyright notice(s) and this permission notice appear in all copies of the Software and that both the above copyright notice(s) and this permission notice appear in supporting documentation.

Software developed by Kevin Atkinson. Copyright © 2000-2004, by Kevin Atkinson. All rights reserved.

Aspell 0.60.2, from the Free Software Foundation, Inc. (<http://www.fsf.org/>), which is subject to the GNU Lesser General Public License Version 2.1 (<http://www.gnu.org/licenses/lgpl.html>). Software distributed under this license is distributed on an "AS IS" basis, WITHOUT WARRANTY OF ANY KIND, either express or implied. See the license for the specific language governing rights and limitations under the license.

Software developed by xqDoc.org. Copyright © 2005 Elsevier, Inc. All rights reserved.

Software developed by Info-ZIP. Copyright © 1990-2004 Info-ZIP. All rights reserved. For the purposes of this copyright and license, "Info-ZIP" is defined as the following set of individuals: Mark Adler, John Bush, Karl Davis, Harald Denker, Jean-Michel Dubois, Jean-loup Gailly, Hunter Goatley, Ian Gorman, Chris Herborth, Dirk Haase, Greg Hartwig, Robert Heath, Jonathan Hudson, Paul Kienitz, David Kirschbaum, Johnny Lee, Onno van der Linden, Igor Mandrichenko, Steve P. Miller, Sergio Monesi, Keith Owens, George Petrov, Greg Roelofs, Kai Uwe Rommel, Steve Salisbury, Dave Smith, Christian Spieler, Antoine Verheijen, Paul von Behren, Rich Wales, Mike White. Info-ZIP software is provided "as is", without warranty of any kind, express or implied. In no event shall Info-ZIP or its contributors be held liable for any direct, indirect, incidental, special or consequential damages arising out of the use of or inability to use this software.

Software developed by Tim Bray and Sun Microsystems and is distributed on an "AS IS" basis, WITHOUT WARRANTY OF ANY KIND, either express or implied. Copyright © 2004 Tim Bray and Sun Microsystems. All rights reserved.

Software developed by Saxonica Limited and is distributed on an "AS IS" basis WITHOUT WARRANTY OF

ANY KIND, either express or implied. Copyright © 2005 Saxonica Limited. All rights reserved.

Software developed by the The Anti-Grain Geometry Project. Copyright © 2002-2005 Maxim Shemanarev (McSeem). This software is provided "as is" without express or implied warranty, and with no claim as to its suitability for any purpose.

DataDirect XQuery

DataDirect XML Converters

DataDirect XML Converters include:

JavaMail and JavaBeans Activation Framework software developed by Sun Microsystems. Copyright © 1994-2006, Sun Microsystems, Inc. All rights reserved.

Software developed by World Wide Web Consortium. Copyright (c) 1998-2003 World Wide Web Consortium (Massachusetts Institute of Technology, European Research Consortium for Informatics and Mathematics, Keio University). All Rights Reserved.

Software developed by World Wide Web Consortium. Copyright (c) 1998-2000 World Wide Web Consortium (Massachusetts Institute of Technology, Institut National de Recherche en Informatique et en Automatique, Keio University). All Rights Reserved.

Software developed by JSON.org. Copyright (c) 2002 JSON.org. All rights reserved.

December2007

Preface	9
What are DataDirect XML Converters™?	9
Using This Book	10
Typographical Conventions	11
Contacting Technical Support	12
1 DataDirect XML Converters™ Overview	15
Types of XML Converters	15
XML Converters Can Be Customized	17
Data Access	18
URL Schemes	19
Command Line Usage	19
Usage Notes	20
Handling Proprietary EDI Formats	20
Example	21
Error Handling Support	21
Error Listener Interface	21
Exception Handling	22
Example	22
XML Schema Generation	23
Command Line Usage	23
Example Scenario	24
Instance Documents	26
URI Parameters That Affect XML Schema	26
XML Schema Generation Summary	30
Namespace Summary	31
Microsoft Help 2.0 Documentation for the XML Converters API	31
DDTek.XmlConverter Namespace	31

Example Applications	35
Converting EDI to XML	35
Creating XML Schemas from EDI	36
2 XML Converters™ URL Schemes	37
The converter: URL Scheme	37
Example	37
XML Converter Properties	38
Invoking a Custom XML Conversion	39
Invoking a Converter URL in XSLT	39
Converter URL Syntax	41
Using Stylus Studio to Build a Converter URL	41
Where Converter URLs are Displayed in Stylus Studio	42
3 Sample XML Converters™ Applications	43
Overview of the demo.cs Example	43
Demonstration Files	44
Running demo.cs	45
How to Run the Demonstration	45
Example 1	46
Example 2	47
Example 3	48
Example 4	49
Example 5	51
Example 6	52
Example 7	53
Example 8	54
Sample Application	54
ConverterListener Implementation in demo.cs	55
Error Listener Output	55

Example 9	57
Example 10	58
4 XML Converters™ Properties	59
Line Separator Values	60
Base-64 XML Converter Properties	61
XML Converter Name in URL	61
Binary XML Converter Properties	62
XML Converter Name in URL	62
Comma-Separated Values (CSV) XML Converter Properties	63
XML Converter Name in URL	63
dBase XML Converter Properties	65
XML Converter Names in URL	65
Datatypes Supported by Version	66
DIF XML Converter Properties	67
XML Converter Name in URL	67
EDI XML Converter Properties	68
XML Converter Name in URL	68
Properties for All EDI XML Converters	68
Properties for HL7 EDI XML Converters	80
Using Special Characters for Separators	83
EDI Processing Instructions	88
E-mail Mbox XML Converter Properties	90
XML Converter Name in URL	90
HTML Converter Properties	91
XML Converter Name in URL	91
Java .properties File XML Converter Properties	92
XML Converter Name in URL	92
JSON XML Converter Properties	93
XML Converter Name in URL	93

OpenEdge .d Data Dump XML Converter Properties.	94
XML Converter Name in URL.	94
Pyx Format XML Converter Properties	95
XML Converter Name in URL.	95
Rich Text Format XML Converter Properties.	96
XML Converter Name in URL.	96
SDI XML Converter Properties	97
XML Converter Name in URL.	97
SYLK XML Converter Properties	98
XML Converter Name in URL.	98
Tab-Separated Values XML Converter Properties.	99
XML Converter Name in URL.	99
Whole-line Text XML Converter Properties	101
XML Converter Name in URL.	101
Windows .ini File XML Converter Properties	102
XML Converter Name in URL.	102
Windows Write XML Converter Properties.	103
XML Converter Name in URL.	103
Index	105

Preface

This book is your guide and reference to DataDirect XML Converters™ from DataDirect Technologies and describes how to use DataDirect XML Converters to build .NET applications that provide bi-directional access to non-XML data. This book provides information about the following topics:

- The converter: URL scheme
- Using DataDirect XML Converters to convert non-XML sources (like EDI and legacy file formats) to XML
- Using DataDirect XML Converters to convert XML to non-XML format (like CSV and tab-delimited files)
- Examples and tutorials that show how you can use DataDirect XML Converters in your environment
- XML Converters properties reference

What are DataDirect XML Converters™?

DataDirect XML Converters™ are high-performance Java™ and .NET components that provide bi-directional, programmatic access to virtually any non-XML file including EDI, flat files, and other legacy formats. DataDirect XML Converters allow developers to seamlessly stream any non-XML data as XML to industry-leading XML processing components or to any application. They support StAX, SAX, XmlReader, XmlWriter, DOM and I/O streaming interfaces, and can be embedded directly for translation purposes, or as part of a chain of programs including XSLT and XQuery, or even inside XML pipelines. DataDirect XML Converters maximize developer

productivity and provide a fast, scalable solution for converting between EDI and other legacy formats and XML.

Using This Book

This manual describes DataDirect XML Converters and how to use them to develop .NET applications. It is assumed that you are familiar with XML, .NET, and related technologies.

This manual has the following chapters:

- [Chapter 1, “DataDirect XML Converters™ Overview”](#) provides an overview of the DataDirect XML Converters API and URL schemes used for data integration.
- [Chapter 2, “XML Converters™ URL Schemes”](#) describes the converter: URL scheme and how to use Stylus Studio XML Enterprise Suite to build converter: URLs.
- [Chapter 3, “Sample XML Converters™ Applications”](#) describes demo.cs, a simple C# program installed with the XML Converters, including how to run it, and detailed information about the actions performed by the example applications it contains.
- [Chapter 4, “XML Converters™ Properties”](#) describes values for the properties for XML Converters.

Typographical Conventions

This book uses the following typographical conventions:

Convention	Explanation
<i>italics</i>	Introduces new terms that you may not be familiar with, and is used occasionally for emphasis.
bold	Emphasizes important information. Also indicates button, menu, and icon names on which you can act. For example, click Next .
UPPERCASE	Indicates keys or key combinations that you can use. For example, press the ENTER key.
monospace	Indicates syntax examples, values that you specify, or results that you receive.
<i>monospaced italics</i>	Indicates names that are placeholders for values you specify; for example, <i>filename</i> .
forward slash /	Separates menus and their associated commands. For example, Select File / Copy means to select Copy from the File menu.
vertical rule	Indicates an OR separator to delineate items.
brackets []	Indicates optional items. For example, in the following statement: SELECT [DISTINCT], DISTINCT is an optional keyword.
braces { }	Indicates that you must select one item. For example, {yes no} means you must specify either yes or no.
ellipsis . . .	Indicates that the immediately preceding item can be repeated any number of times in succession. An ellipsis following a closing bracket indicates that all information in that unit can be repeated.

Contacting Technical Support

DataDirect Technologies offers a variety of options to meet your technical support needs. Please visit our Web site for more details and for contact information:

<http://support.datadirect.com>

The DataDirect Technologies Web site provides the latest support information through our global service network. The SupportLink program provides access to support contact details, tools, patches, and valuable information, including a list of FAQs for each product. In addition, you can search our Knowledgebase for technical bulletins and other information.

To obtain technical support for an evaluation copy of the product, go to:

http://www.datadirect.com/support/eval_help/index.ssp

or contact your sales representative.

When you contact us for assistance, please provide the following information:

- The serial number that corresponds to the product for which you are seeking support, or a case number if you have been provided one for your issue. If you do not have a SupportLink contract, the SupportLink representative assisting you will connect you with our Sales team.
- Your name, phone number, email address, and organization. For a first-time call, you may be asked for full customer information, including location.
- The DataDirect product and the version that you are using.
- The type and version of the operating system where you have installed your DataDirect product.

- Any EDI, flat file, legacy file, custom XML conversion definition, or other environment information required to understand the problem.
- A brief description of the problem, including, but not limited to, any error messages you have received, what steps you followed prior to the initial occurrence of the problem, any trace logs capturing the issue, and so on. Depending on the complexity of the problem, you may be asked to submit an example or reproducible application so that the issue can be recreated.
- A description of what you have attempted to resolve the issue. If you have researched your issue on Web search engines, our Knowledgebase, or have tested additional configurations, applications, or other vendor products, you will want to carefully note everything you have already attempted.
- A simple assessment of how the severity of the issue is impacting your organization.

1 DataDirect XML Converters™ Overview

DataDirect XML Converters is an assembly of .NET classes that provides programmatic bi-directional access to numerous data sources such as EDI, CSV, and other legacy formats as XML through .NET applications.

This chapter provides an overview of the XML Converters, including the types of file formats they support, how they can be used to access data from other sources, and a brief description of the .NET API.

Types of XML Converters

DataDirect XML Converters support numerous file formats, as shown in the following table.

Table 1-1. File Formats Supported by XML Converters

File Class	File Type	Description
EDI Dialects	EANCOM, EDIFACT, HL7, IATA, and X12	Automatically detects and parses EDIFACT, X12, IATA, EANCOM, and HL7 EDI message types, with options for custom message types and message extensions to cover proprietary EDI-based formats.
Flat Files	Base-64	Converts any file, text or binary (such as an image), into a XML document with a single element containing the Base-64 encoded content of the input file.

Table 1-1. File Formats Supported by XML Converters

File Class	File Type	Description
	Binary	Similar to the Base-64 XML Converter, except with hexadecimal output. Other options allow output in other bases, such as decimal or octal or even binary.
	CSV	Converter for comma-separated values (CSV) files. Supports multiple encodings and options to tune the quote and escape characters. Supports delimiters besides commas.
	dBase	Support for dBase II, III, III+, IV, and V formats.
	DIF	Data Interchange Format (DIF) is a spreadsheet-based file format. There are also XML Converters for SDI and SYLK.
	DotD	Support for Progress Software's OpenEdge text dump file format.
	HTML	Support for HTML to XML (XHTML) file conversion.
	JavaProps	Support for Java .properties file format, which are used for program configuration, translation, and data storage.
	JSON	Uses the algorithms on the JSON.org website to read from XML and write to JSON (JavaScript Object Notation), and vice-versa.
	Line	Reads in text one line at a time, wrapping an element around each line and escaping any embedded & or > or < symbols.
	MBox	Parse the standard mbox file format and even handles multi-part messages.
	Pyx	Support for this line-oriented notation for expressing tree-oriented data.
	RTF	Converts rich-text format (RTF) into XML, and vice versa.
	SDI	Super Data Interchange (SDI) is another popular spreadsheet-based file format. There are also XML Converters for DIF and SYLK.
	SYLK	SYLK (Symbolic Link) is another popular spreadsheet-based file format. There are also XML Converters for DIF and SDI.

Table 1-1. File Formats Supported by XML Converters

File Class	File Type	Description
	TAB	Tab-separated values format commonly associated with MS Excel spreadsheets.
	WinIni	Converter for Windows .ini configuration files.
	WinWrite	Converter for Microsoft WinWrite files; renders XHTML.
Custom	Custom	Custom XML conversions (.conv files) created using Stylus Studio.

XML Converters Can Be Customized

Every XML Converter has properties that allow you to tailor the converter to suit your needs. Some XML Converters, for example, let you specify the line separator character, escape character, root element name, and other aspects of the output format. Default values are used for all properties that you do not explicitly specify.

See [Chapter 4 “XML Converters™ Properties” on page 59](#) for more information.

Data Access

XML Converters provide access to non-XML data stored in EDI and flat file formats like CSV, RTF, dBase, binary, and others. The following figure illustrates the different ways you can use XML Converters to access XML and non-XML data from .NET applications or from XSLT code.

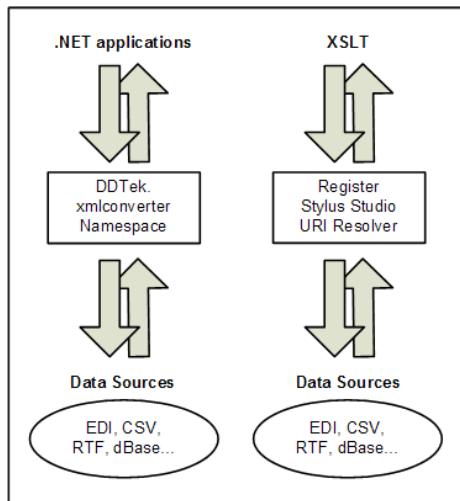

Data access to non-XML data stored as EDI or a flat file (CSV and others) is accomplished using the DataDirect XML Converters `converter: URL` scheme. See ["URL Schemes" on page 19](#) to learn more about the URL schemes supported by XML Converters.

URL Schemes

In .NET, files and other data resources are referenced using URL schemes. The URI resolver is capable of resolving file:, http:, ftp:, and a limited set of other URL schemes –

`http://www.xmlconverters.com/buy`, for example.

The XML Converters .NET API extends the functionality of the basic URI resolver – it recognizes and understands the `converter:` URL scheme developed by DataDirect. You can use the `converter:` URL scheme in your C# and XSLT code.

The `converter:` URL scheme specifies an XML Converter name, either one of the standard XML Converters (for EDI or CSV, for example) or a custom XML conversion created using Stylus Studio XML Enterprise Suite. For example, the URL scheme `converter:myConverter.conv` invokes the custom XML conversion `myConverter.conv` file. The URL scheme `converter:EDI?file:///m:/testing/editeur.edi` invokes the XML Converters EDI converter, using the file `editeur.edi` as the EDI source to be converted.

See [Chapter 2 “XML Converters™ URL Schemes”](#) for more information.

Command Line Usage

You can run DataDirect XML Converters™ from the command line.

To specify a native file to be converted to XML:

```
CmdLine /to /converter <name> /in <filename> [/out  
<filename>]
```

To specify an XML file to be converted to a native format:

```
CmdLine /from /converter <name> /in <filename> [/out  
<filename>]
```

Usage Notes

Following are some usage notes for running DataDirect XML Converters™ from the command line:

- Use `/in -` to read from the standard input.
- To write to the standard output, omit the `/out` parameter.
- You can use dashes (-) instead of forward slashes (/) to separate parameters – for example, `-to` instead of `/to`.
- To generate XML Schema, replace `/to` with `/schema`. See “[XML Schema Generation](#)” on page 23 for more information.

Handling Proprietary EDI Formats

DataDirect XML Converters™ supports the Standard Exchange Format (SEF), which allows you to specify the structure of an EDI document. You can instruct the EDI XML Converter to read your SEF extension file and use it when converting your proprietary EDI to XML.

You can find a copy of the SEF standard specification on the DataDirect XML Converters web site:

<http://www.xmlconverters.com/SEF>

Example

See [“Example 7” on page 53](#) for an example of using an SEF extension file to define an XML Schema.

Error Handling Support

The DataDirect XML Converters™ API provides several ways to manage error handling in your applications.

Error Listener Interface

Warnings and errors do not always need to throw exceptions and abort a conversion process; in these cases it can be desirable to simply make the application aware that a problem has occurred and allow it to recover (or not) from the warning or the error.

The `ConverterListener` interface allows you to intercept warnings, errors, and fatal errors and manage them separately. The default action is to ignore warnings, and to throw exceptions for errors and fatal errors.

Processing can resume after both warnings and errors; by simply not throwing the exception received, processing continues. In the case of an error, it is possible that other errors will cascade from the first. Fatal errors can be reported, but upon return a `ConverterException` is always thrown by the EDI XML Converters™ engine. The exception that is thrown will be an instance of `ConverterException` or one of its subclasses such as `ConverterArgumentException`.

Exception Handling

EDI-based conversions are typically more complex than other types of conversions (those for CSV and tab-delimited files for example). By providing more contextual information about where a problem has occurred, EDI XML Converters™ allow you to capture the error and possibly return standard `CONTROL` EDI messages back to the sender of the message.

The `EDIConverterException` is a specialized version of `ConverterException` that contains extra information about the context of errors in EDI files. When a `ConverterException` is thrown while processing an EDI file, or when a `ConverterListener` is registered and a `warning()`, `error()`, or `fatalError()` is called, in most cases the exception thrown will be `EDIConverterException`.

This exception contains many methods to probe the context of the specific error. Processing can recover from both warnings and errors; fatal errors, however, always end the processing.

Error Diagnostics

Full context information is included when an error is encountered within the EDI file, including the error number according to the local EDI dialect. For example, many EDIFACT errors are recorded in the 0085 element codelist, and if the error occurring matches one of those, it is reported as such.

Example

See [“Example 8” on page 54](#) for an example of registering a `ConverterListener`.

XML Schema Generation

You can use the `SchemaGenerator` interface to create XML Schema files that describe the structure of XML files read or created by a `ConvertToXML` or `ConvertFromXML` object. You might want to use the `SchemaGenerator` interface in the following situations:

- You have a `fromXML` converter: URL, and you want to know the XML Schema that the input XML data must satisfy.
- You have a `toXML` converter: URL, and you want to know the XML Schema of the XML output.
- You have a `toXML` converter: URL and a non-XML data file, and you want to know the XML Schema of the XML output. (This functionality is available only with certain XML Converters. See [“XML Schema Generation Summary” on page 30](#) for more information.)

The XML Schema of the generated file depends on the type of file for which the XML Schema is being created, and not on the actual data. For example, if you are creating an XML Schema for an EDI file, the XML Converter is concerned only with the file’s dialect, version, and message type/transaction set. You can specify this information by providing a sample file input, or by specifying the appropriate properties in the `converter: URL`. See [“Instance Documents” on page 26](#) and [“URI Parameters That Affect XML Schema” on page 26](#) for more information.

Command Line Usage

To generate XML Schema from the command line:

```
CmdLine /schema /converter <name> /in <filename> [/out  
<filename>]
```

Note that some XML Converters (like EDI, for example) require that you either provide an instance document or specify XML Schema properties in the `converter: URL`.

Example Scenario

Consider the following example scenario: your enterprise routinely receives client data in EDI files. The data in these files needs to be converted to XML, so that it can be transformed for processing by an application. After application processing, the resulting XML is again transformed to another format before being converted back to EDI.

Such a workflow can be represented with the following diagram:

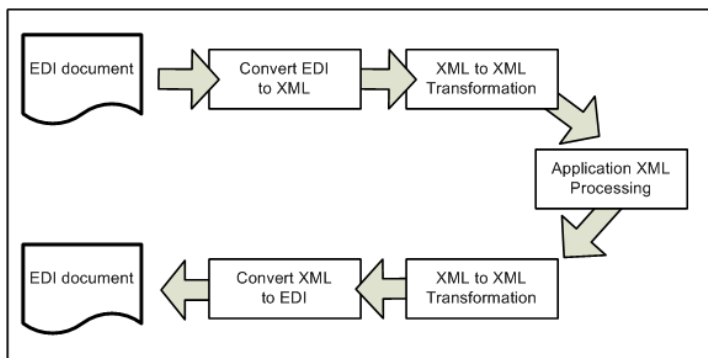

In this illustration, the conversion block *Convert EDI to XML* represents an instance of DataDirect XML Converters™, which is used to convert the incoming EDI document – say it’s an X12 810 transaction set (Invoice). This XML conforms to the XML Schema consistent with the X12 EDI transaction set from which it was derived. However, before the XML can be used by the processing application, it needs to be transformed into the format (that is, it must conform to an XML Schema) expected by the processing application.

Imagine that XQuery is used to perform this transformation (the block *XML to XML Transformation* in the preceding illustration).

One way to create such an XQuery is to use a mapping tool. In this case, we map nodes from the XML Schema representing the EDI X12 810 transaction set to the XML Schema representing the document format expected by the XML processing application. Here, we use DataDirect XML Converters™ to create the XML Schema for the EDI X12 810 transaction set, as shown in the following illustration.

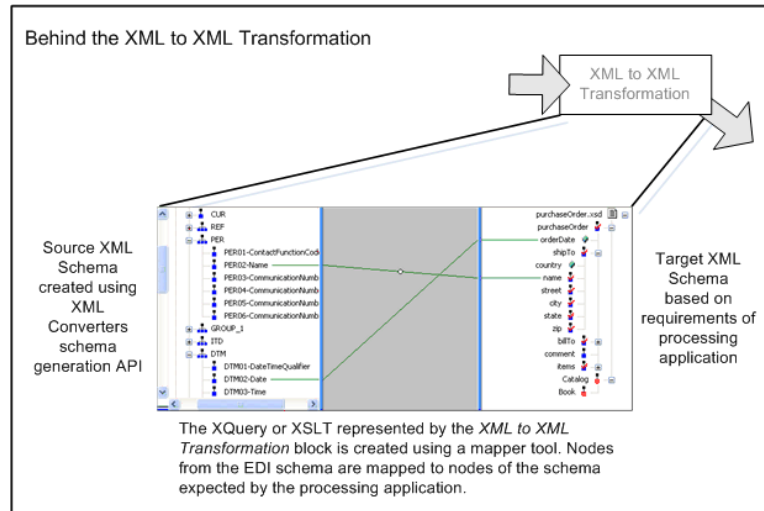

A similar mapping process is performed to create the second XML to XML transformation (another XQuery), this time mapping XML Schema nodes from the application format to the EDI X12 810 transaction set format to create an XQuery. This XQuery transforms the XML data to a format that can be understood by the DataDirect XML Converters™.

See [“Creating XML Schemas from EDI” on page 36](#) for an example of using DataDirect XML Converters™ to create XML Schema from an EDI document.

Instance Documents

Some XML Converters, like those for CSV and Tab, require an instance document in order to provide DataDirect XML Converters™ with the information it needs to generate an XML Schema. Other XML Converters (like EDI) can use instance documents, but they are not required; for this type of file, you can provide information using `converter: URL` properties to specify characteristics of the generated XML Schema. Still others (Base64 and SDI, for example) use neither instance documents nor `converter: URL` properties, relying instead on DataDirect XML Converters™ built-in settings for XML Schema generation for files of that type.

See [“XML Schema Generation Summary” on page 30](#) for more information concerning instance document and `converter: URL` property usage for XML Converters.

URI Parameters That Affect XML Schema

This section describes how URI parameters affect XML Schema generation for the XML Converters that support their use. The XML Converters for which you can specify URI parameters are:

- CSV
- EDI
- Line
- Tab
- *custom* (built using Stylus Studio)

CSV XML Converter URI Parameters

The following parameters affect XML Schema generation for both CSV and tab-delimited files:

Table 1-2. Parameters for CSV and Tab XML Converters

Property	Description
root=	Specifies the name of the root element in converted XML; also specifies the name of the root element in generated XML Schema.
row=	Specifies the name of the row element in converted XML; also specifies the name of the row element in generated XML Schema.
first=	Specifies whether elements subordinate to the row element are named column (plus a number to make it unique) or are given their name based on the first row of data.

EDI XML Converter URI Parameters

The following parameters affect XML Schema generation for EDI files:

Table 1-3. Parameters for EDI XML Converters

Property	Description
dialect=	Must be one of the following: EANCOM, EDIFACT, HL7, IATA, or X12. Required if an instance document is not provided.
version=	Varies based on the dialect. Examples for EDIFACT include 921 and D07A; examples for HL7 include 2.1 and 2.5; examples for IATA include 991 and 992; and so on. Required if an instance document is not provided.
message=	Varies based on the dialect and version. Examples for EDIFACT include CONTRL and ORDERS; examples for HL7 include ACK and ADT_A01; examples for IATA include SPORES and TKTRES; and so on. Required if an instance document is not provided.
inter=	Set to "yes" for interactive messages; set to "no" (the default) for batch. This parameter is ignored if it does not apply. Must be set to "yes" if an instance document is not provided.
tbl=	Whether or not you want to generate codelist enumerations in the XML Schema. Default is "yes."
doc=	Whether or not to include <code>xs:documentation</code> comments in the XML Schema. Default is "yes."

Table 1-3. Parameters for EDI XML Converters

Property	Description
long=	Whether or not to generate long element names. Default is "yes;" setting this parameter to "no" generates short element names.
user=	Optionally specifies an external .sef file, whose structure is incorporated in the generated XML Schema.

Line XML Converter URI Parameters

The following parameters affect XML Schema generation for whole-line text files:

Table 1-4. Parameters for Line XML Converters

Property	Description
root=	Specifies the name of the root element in converted XML; also specifies the name of the root element in generated XML Schema.
line=	Specifies the name of the element that wraps each line in converted XML; also specifies the name of that element in generated XML Schema.

Tab XML Converter URI Parameters

See ["CSV XML Converter URI Parameters"](#) on page 27.

XML Schema Generation Summary

The following table summarizes information about the XML Schema generation capabilities of DataDirect XML Converters. Note that not all XML Converters can generate XML Schema.

Table 1-5. XML Converters That Can Generate XML Schema

Converter Name	Can Generate XML Schema	Instance Document	URI Parameters Affect XML Schema
Base64	Yes	Not needed	No
Binary	Yes	Not needed	No
CSV	Yes	Mandatory	Yes
<i>custom</i>	Yes	Not needed	via .conv file
dBase (all)	Yes	Mandatory	No
DIF	Yes	Not needed	No
DotD	Yes	Not needed	No
EDI (all)	Yes	Optional	Yes
HTML	No	n/a	n/a
JavaProps	Yes	Not needed	No
JSON	No	n/a	n/a
Line	Yes	Not needed	Yes
Mbox	No	n/a	n/a
Pyx	No	n/a	n/a
RTF	No	n/a	n/a
SDI	Yes	Not needed	No
Sylk	Yes	Not needed	No
Tab	Yes	Mandatory	Yes
WinIni	Yes	Not needed	No
WinWrite	Yes	Not needed	No

Namespace Summary

This section provides a brief description of the DDTek.XmlConverter namespace. For complete information, see the Microsoft Help 2.0 documentation for the XML Converters.

Microsoft Help 2.0 Documentation for the XML Converters API

Microsoft Help 2.0 documentation for the XML Converters API is installed in the /vs.net folder where you installed the XML Converters. If you chose to register the documentation during the DataDirect XML Converters installation, DataDirect Xmlconverters appears on the Contents tab the next time you start Microsoft Visual Studio. You can register the XML Converters documentation at any time by selecting XML Converters Help Integration with Visual Studio 2005 from the DataDirect XML Converters program group.

DDTek.XmlConverter Namespace

You use the classes and interfaces in the DDTek.Xmlconverter namespace to access EDI, CSV, and other flat-file data sources from an application using the `converter: URL` scheme.

Classes

Class	Description
Configuration	A Configuration object contains user settable policies that govern certain aspects of the conversion process.

Class	Description
Conversion	A Conversion object contains all the information needed during an ongoing conversion.
ConversionStatus	Contains the current status of a Conversion.
ConverterFactory	The ConverterFactory class allows the user to specify configuration parameters with the Configuration property and create instances of Converter and ConverterResolver.
ConverterResolver	An implementation of XmlResolver which can resolve <code>converter:</code> URIs, execute the appropriate Converter and return the result data as an InputStream or XmlReader.
DocumentResult	A DocumentResult can be used to accept XML result data from a to-XML Converter. After the conversion has finished, the DocumentResult will contain an XPathNavigable object.
DocumentSource	A DocumentSource can be used to provide XML source data to a from-XML Converter. The data is provided as an XPathNavigable object.
InputStreamResult	Class used to specify that the user of Converter wants to read the result of the conversion with a InputStream.
InputStreamSource	An InputStreamSource can be used to provide either non-XML or XML source data for a Converter.
OutputStreamResult	An OutputStreamResult can be used to accept either non-XML or XML result data from a Converter.
OutputStreamSource	An OutputStreamSource can be used to push byte stream source data into a to-XML or from-XML Converter.

Class	Description
Result	Implementations of the abstract Result class are used to get result data from a Converter. The result data may be XML data from a to-XML Converter, or non-XML data from a from-XML Converter.
Source	Implementations of the abstract Source class are used to provide data to a Converter. The data may be non-XML source data for a to-XML Converter, or-XML source data for a from-XML Converter.
TextReaderResult	A TextReaderResult can be used to read character stream result data from a to-XML or from-XML Converter.
TextReaderSource	A TextReaderSource can be used to provide either non-XML or XML source data for a Converter.
TextWriterResult	A TextWriterResult can be used to accept either non-XML or XML result data from a Converter.
TextWriterSource	A TextWriterSource can be used to push byte stream source data into a to-XML or from-XML Converter.
UriResult	A UriResult can be used to accept either non-XML or XML result data from an Converter.
UriSource	A UriSource can be used to provide either non-XML or XML source data for an Converter.
XmlReaderResult	An XmlReaderResult can be used to read XML result data from a to-XML Converter.
XmlReaderSource	An XmlReaderSource can be used to provide XML source data to a from-XML Converter.

Class	Description
XmlWriterResult	An XmlWriterResult can be used to accept XML result data from a to-XML Converter.
XmlWriterSource	An XmlWriterSource can be used to push XML source data into a from-XML Converter.

Interfaces

Class	Description
Converter	Performs the conversion of XML to non-XML, and vice versa.
ConverterListener	Error reporting interface.
ConvertFromXML	An extension of Converter that specifies methods used only in conversions from XML to non-XML.
ConvertToXML	An extension of Converter that specifies methods used only in conversions from non-XML to XML.
SchemaGenerator	Used to create XML Schema files that describe the structure of XML files read or created by a Converter, ConvertToXML, or ConvertFromXML object

Example Applications

This section presents two simple applications: one showing the conversion of an EDI file to XML, and another that shows how to use the API to create an XML Schema from an EDI file.

See [Chapter 3 “Sample XML Converters™ Applications” on page 43](#) for other application examples.

Converting EDI to XML

Following is a simple example application that reads EDI from one file (`myEdi.x12`) and writes XML to another (`myEdi.x12.xml`).

```
using System;
using System.Collections.Generic;
using System.Text;
using DDTek.XmlConverter;

namespace ConverterOne
{
    class Program
    {
        static void Main(string[] args)
        {
            Console.Out.WriteLine(args[0] + " --> " + args[1]);
            Converter toXML = new ConverterFactory().CreateConvertFromXml
                ("converter:EDI");
            toXML.Convert(new UriSource(args[0]), new UriResult(args[1]));
        }
    }
}
```

This program can be invoked from a command line as follows:

```
ConverterOne file:///c:/path/myEdi.x12 file:///c:/path/myEdi.x12.xml
```

Creating XML Schemas from EDI

Following is a simple example that shows a C# program that generates XML Schema for EDIFACT version D07A; the name of the message being converted (in this case, ORDERS), is taken from the command line, which might look like this:

```
com.ddtek.example.CreateEdifactSchema ORDERS
```

In this example, the XML Schema is written to the console.

```
using System;
using DDTek.XmlConverter;
namespace Example
{
    public class CreateEdifactSchema {
        static void Main(String[] args) {
            String uri = "EDI:dialect=EDIFACT:version=D07A:long=yes:message=" +
args[0];
            try {
                ConverterFactory factory = new ConverterFactory();
                SchemaGenerator schema = factory.CreateSchemaGenerator(uri);
                Result twr = new TextWriterResult(Console.Out);
                schema.GetSchema(twr);
            } catch (ConverterException ce) {
                Console.WriteLine(ce.Message);
            }
        }
    }
}
```

2 XML Converters™ URL Schemes

You can use the converter: URL scheme to reach a variety of data sources using DataDirect XML Converters. The converter: URL scheme can also be used with user-defined custom XML conversions created using Stylus Studio XML Enterprise Suite.

The converter: URL Scheme

To specify a converter: URL, you need to identify

- The XML Converter you want to use (EDI, CSV, dBase, and so on)
- Options for that XML Converter (separator and escape characters, for example)
- The file to be converted

For more information, see [“Converter URL Syntax” on page 41](#).

Example

A converter: URL that invokes the DataDirect XML Converter for comma-separated values to convert the `three.txt` file in the `\XMLConverters\examples\` directory to XML document might look like this:

```
converter:CSV:newline=lf:first=yes?file:///c:/XMLConverters/examples/  
three.txt
```

The instructions to the XML Converter engine from this instance of the converter URL are described the following table.

Instruction	Converter URL String
Use the Comma-Separated Values XML Converter converter	converter:csv
The line separator in the source file is a line feed	newline=lf
The values in the first row of the source file should be used to supply field names	first=yes
The source file is three.txt	file:///c:/XMLConverters/examples/three.txt

NOTE: Properties that use default values (a comma is the default separator character for the CSV XML Converter, for example) do not have to be specified in the URL.

XML Converter Properties

While the basic format of the converter URL is the same from one XML Converter to another, XML Converters have different properties. For example, the XML Converter for dBase files has settings that the XML Converter for binary files does not.

TIP: If you have Stylus Studio XML Enterprise Suite, you can use Stylus Studio to build your converter URLs. See [“Using Stylus Studio to Build a Converter URL” on page 41](#) for more information. Otherwise, you must construct the converter URL manually, taking care to specify both setting names and their values correctly. For a complete description of properties for all XML Converters, see [Chapter 4 “XML Converters™ Properties”](#).

Invoking a Custom XML Conversion

The converter: URL scheme can also be used to reference a custom XML conversion (a .conv file) built using Stylus Studio XML Enterprise Suite. In this case, the converter URL specifies only the location of the .conv file; the converter itself contains information about its property settings. A converter URL that references a custom XML conversion might look like this:

```
converter:///myConverter.conv?file:inventory.txt
```

This converter uses myConverter.conv to convert the file inventory.txt to some format (specified in the converter when you built it using Stylus Studio XML Enterprise Suite).

NOTE: Custom XML conversions can *only* be defined using Stylus Studio XML Enterprise Suite.

Invoking a Converter URL in XSLT

The .NET Framework uses a document URI resolver that enables the document() function to take a converter: URL as its argument.

Consider the following example of the document() function, which invokes the CSV XML Converter to convert the file one.csv to XML:

```
document('converter:///CSV:sep=,:first=yes?' + exampleDir + @"one.csv')
```

In this example, only one of the CSV XML Converters properties is set (first=yes); default settings are used for all other properties.

Here is the document() function in the context of a code sample that shows the use of XML Converter as XmlResolver. The transformation combines one.xml with one.csv into seven.xml.

The XSLT processor resolves one.csv through the XmlResolver implementation provided by the ConverterFactory class

```
try{
    String xsltString =
    @"<xsl:stylesheet version='1.0'
      xmlns:xsl='http://www.w3.org/1999/XSL/Transform'>
      <xsl:output method='xml' indent='yes' />
      <xsl:template match='/'>
      <root>
        <xsl:copy-of select='.' />
        <xsl:copy-of select=""
          document('converter:///CSV:sep=,:first=yes?' + exampleDir
            + @"one.csv') "" />
      </root>
      </xsl:template>
    </xsl:stylesheet>";

    XsltCompiledTransform xslt = new XsltCompiledTransform();
    XsltSettings settings = new XsltSettings(true, false);
    xslt.Load(XmlReader.Create(new StringReader(xsltString)),
      settings, null);
    xslt.Transform(
      XmlReader.Create(exampleDir + "one.xml"),
      new XsltArgumentList(),
      XmlWriter.Create(exampleDir + "seven.xml"),
      factory.CreateResolver());
    Console.WriteLine("test 7 finished: one.xml + one.csv ->
      seven.xml");
  }
  catch (Exception e)
  {
    Console.WriteLine("test 7 failed with exception: " + e);
  }
}
```

TIP: You can copy this code and paste it at the end of demo.cs, and it will run along with the other examples. See [“Running demo.cs” on page 45](#) for more information.

Converter URL Syntax

While properties differ from one XML Converter to the next, the syntax used to invoke them is the same:

```
converter:name:[property_name=value: | property_name=value: | ...]?file:file  
URL
```

Example:

```
converter:Base64:newline=crlf?file:///w:/myfiles/base_to_xml.bin
```

In this example:

- The name of the XML Converter is Base64. It could be any XML Converter – EDI, CSV, DIF, RTF, and so on.
- Only the newline property has been specified; default values are used for all other converter properties.
- The file being converted is `base_to_xml.bin` on `w:\myfiles`.

Using Stylus Studio to Build a Converter URL

If you have Stylus Studio XML Enterprise Suite, you can use Stylus Studio to construct the converter URLs you use in your .NET applications. Converter URLs can be complex – properties and their values vary from one converter to another, for example – and long, so using Stylus Studio to construct them can reduce errors in your applications.

Where Converter URLs are Displayed in Stylus Studio

If you are using Stylus Studio XML Enterprise Suite, you can view converter URLs

- In the **Project** window (select **Show Full URL** from the **Project** window shortcut menu)

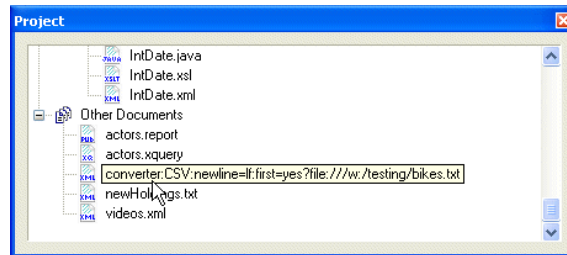

- In the **URL** field of the **Select XML Converter** dialog box, as shown in the following illustration.

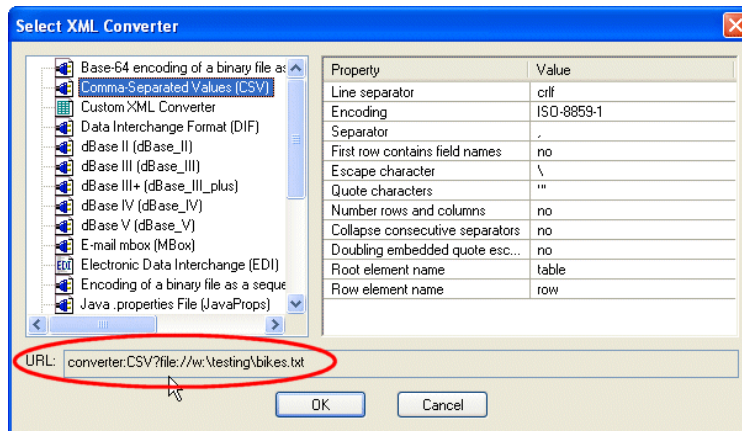

You can use either source for the converter URL strings in your .NET applications. For more information, see the Stylus Studio product documentation.

3 Sample XML Converters™ Applications

The DataDirect XML Converters API allows you to access and convert non-XML files to XML, and vice versa. The converter URLs used to access data sources can be invoked programmatically, in an XSLT application, for example, allowing you to treat non-XML data as XML, manipulate it as needed, and, optionally, write it back to its source in its original format.

This chapter describes `demo.cs`, a simple .NET program installed in the DataDirect XML Converters \examples folder.

Overview of the `demo.cs` Example

The example file, `demo.cs`, runs several sample demonstrations that show how the XML Converters API can be used to convert data to and from XML stored in a number of different formats using both DataDirect XML Converters and user-defined custom XML conversions created using Stylus Studio. This section describes the files associated with the demonstrations and how to run it.

Demonstration Files

The files required to run the demonstrations are summarized in the following table. All of these files are installed in the `\examples` directory where you installed the XML Converters.

File	Description
<code>831.x12</code>	EDI file used in Example 6.
<code>copier.xslt</code>	XSLT used in Example 4 and Example 5.
<code>proprietary.x12</code>	Sample X12 with a non-standard message type; used in Example 7.
<code>proprietary.sef</code>	SEF file that defines non-standard X12 message types; used in Example 7.
<code>demo.cs</code>	The source for the demonstration; this file contains the usage comments.
<code>DemoApplication.csproj</code>	The Visual Studio project file for <code>demo.cs</code> .
<code>DemoApplication.sln</code>	The Visual Studio solution file for <code>demo.cs</code> .
<code>one.csv</code>	The input file for the first example.
<code>three.conv</code>	The definition for the custom XML conversion used in the third example.
<code>three.txt</code>	The input file for the third example.
<code>two.xml</code>	The input file for the second example.

Running demo.cs

This section describes the requirements and procedure for running the demonstration application, demo.cs.

How to Run the Demonstration

To start the demo.cs demonstration:

- 1 Start Microsoft Visual Studio 2005.
- 2 Open DemoApplication.sln.
- 3 Press Ctrl+F5 to run the project.

Example 1

Example 1 converts a comma-separated values (CSV) file, `one.csv`, to an XML file, `one.xml`, using the CSV XML Converter. The conversion parameter for the new Converter object is specified as a converter: URL that indicates which XML Converter to use to convert the input file to the output file. Only two XML Converter property settings are expressed; default values are used for all properties unless you specify them in the converter: URL.

```
try {
    Source converterSource = new UriSource(exampleDir + "one.csv");
    Result converterResult = new UriResult(exampleDir + "one.xml");

    Converter toXml = factory.CreateConvertToXml("converter:CSV:sep=,
        :first=yes");
    toXml.Convert(converterSource, converterResult);

    Console.WriteLine("test 1 finished: one.csv -> one.xml");
}
catch(Exception e) {
    Console.WriteLine("test 1 failed with exception: " + e);
}
```

Both input and output streams are opened and closed by the Converter object.

Example 2

Example 2 is similar to Example 1, but instead of converting a non-XML file to XML, it does the opposite. It also shows how to use the URI resolver to create both the input stream and output stream:

```
try {
    ConverterResolver resolver = factory.CreateResolver();
    Uri inputUri = resolver.ResolveUri(uriBase, "two.xml");
    using (Stream inStream = (Stream) resolver.GetEntity(inputUri, null,
        typeof(Stream))) {

        Source converterSource = new InputStreamSource(inStream);

        using (Stream outStream = File.OpenWrite(exampleDir + "two.csv")) {

            Result converterResult = new OutputStreamResult(outStream);

            Converter fromXml = factory.CreateConvertFromXml
                ("converter:CSV:sep=,:first=yes");
            fromXml.Convert(converterSource, converterResult);
        }
    }

    Console.WriteLine("test 2 finished: two.xml -> two.csv");
}
catch(Exception e) {
    Console.WriteLine("test 2 failed with exception: " + e);
}
```

In this example, we need to close the input and output streams since we, and not the Converter object, opened them.

Example 3

Example 3 uses a custom XML conversion, `three.conv`, built using Stylus Studio XML Enterprise Suite, to convert a fixed-width file, `three.txt`, to XML. Here, we create our own Streams – because we are converting a local text file, there is no need to use the URI Resolver.

```
try {
    using (Stream inStream = File.OpenRead(exampleDir + "three.txt") ) {
        using (Stream outStream = File.OpenWrite(exampleDir + "three.xml") ){
            Source converterSource = new InputStreamSource(inStream);
            Result converterResult = new OutputStreamResult(outStream);

            String converter = "converter:" + exampleDir + "three.conv";

            Converter toXml = factory.CreateConvertToXml(converter);
            toXml.Convert(converterSource, converterResult);

        }

    }

    Console.WriteLine("test 3 finished: three.txt -> three.xml");
}
catch(Exception e) {
    Console.WriteLine("test 3 failed with exception: " + e);
}
```

Example 4

Examples 1, 2, and 3 performed simple conversion of one file type to another – some type of converter (either a DataDirect XML Converter or a user-defined custom XML conversion) was given an input and converted it to another format.

In Example 4, the Converter converterResult will make the Converter output available as an XmlReader. The XSLT Transformer will read the data from the XmlReader. The Converter will not actually process the input data until the XSLT Transformer starts to read from the XmlReader. The Converter will then begin converting the input data, as needed. If the transformer terminates early, without reading all the data, the Converter will also terminate without converting all the input data.

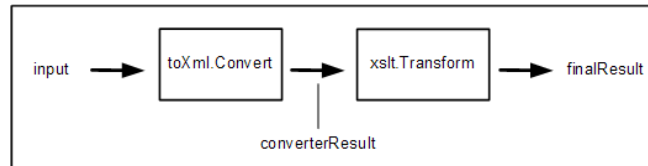

Here is the code for Example 4:

```
try {
    using(Stream inputStream = File.OpenRead(exampleDir + "one.csv")){
        InputSource converterSource = new InputSource(inputStream);

        XmlReaderResult converterResult = new XmlReaderResult();

        Converter toXml = factory.CreateConvertToXml("converter:///CSV:sep=,
            :first=yes");
        toXml.Convert(converterSource, converterResult);

        XslCompiledTransform xslt = new XslCompiledTransform();
        xslt.Load(exampleDir + "Copier.xslt");
        XmlWriterSettings settings = new XmlWriterSettings();
        settings.Indent = true;
        settings.IndentChars = "\t";
        XmlWriter writer = XmlWriter.Create(exampleDir + "four.xml", settings);
        xslt.Transform(converterResult.XmlReader, writer);
        converterResult.XmlReader.Close();
    }

    Console.WriteLine("test 4 finished: one.csv -> four.xml");
}
catch(Exception e) {
    Console.WriteLine("test 4 failed with exception: " + e);
}
```

XmlWriter writer is an XML document, four.xml. In this example, we used a copy/identity transformation, but you could specify any XSLT transformation here to perform any processing on the intermediate result you required.

Example 5

In Example 5, output from an XSLT transformation is sent to a converter, which takes the XML that is written to it (as an `XmlWriter`) and converts it to CSV. This process is summarized in the following illustration.

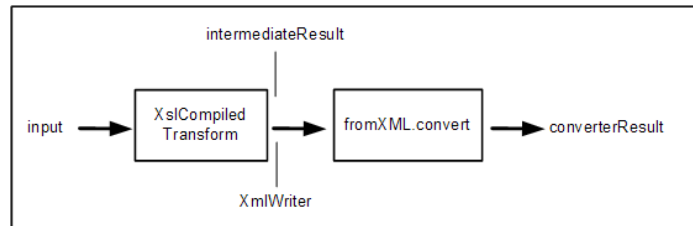

Here is the code for Example 5:

```

try {
    UriResult converterResult = new UriResult(exampleDir + "five.csv");

    XmlWriterSource converterSource = new XmlWriterSource();

    ConvertFromXml fromXml =factory.CreateConvertFromXml("converter:CSV:
        sep=,:first=yes");
    XmlWriter xmlWriter = fromXml.GetXmlWriter(converterResult);

    XslCompiledTransform xslt = new XslCompiledTransform();
    xslt.Load(exampleDir + "Copier.xslt");
    xslt.Transform(exampleDir + "two.xml", xmlWriter);

    Console.WriteLine("test 5 finished: two.xml -> five.csv");
}
catch(Exception e) {
    Console.WriteLine("test 5 failed with exception: " + e);
}

```

To convert the transformation's output to CSV, we have used an instance of the `ConvertFromXML` object. This object uses the XML Converters CSV converter.

Example 6

Example 6 shows the use of an EDI XML Converter (converter: EDI) to convert a file in the X12 dialect (831.x12) to XML (831.x12.xml), and then back to EDI (831.x12.xml.fromxml).

```
try{
    Source converterSource = new UriSource(exampleDir + "831.x12");
    Result converterResult = new UriResult(exampleDir + "831.x12.xml");
    Converter toXml = factory.CreateConvertToXml("converter:EDI");
    toXml.Convert(converterSource, converterResult);
    Console.WriteLine("test6 toXML finished: 831.x12 -> 831.x12.xml");
}
catch (Exception e)
{
    Console.WriteLine("test 6 toXML failed with exception: " + e);
}

try{
    Source converterSource = new UriSource(exampleDir + "831.x12.xml");
    Result converterResult = new UriResult(exampleDir +
        "831.x12.fromxml");
    Converter fromXml = factory.CreateConvertFromXml("converter:EDI");
    fromXml.Convert(converterSource, converterResult);
    Console.WriteLine("test6 fromXML finished: 831.x12.xml ->
        831.x12.fromxml");
}
catch (Exception e)
{
    Console.WriteLine("test 6 fromXML failed with exception: " + e);
}
```

Example 7

This example shows how to use a Standard Exchange Format (SEF) extension file to convert EDI messages using a proprietary format. The SEF file used in this example adds 99 as a permitted code value in the 353 element of segment BGN in transaction set 831.

The URL of the SEF file is specified in the `user=` parameter of the `converter: URL`. It is also possible to specify the SEF file name as a relative pathname. If XML Converters has been installed in a directory `PRODUCT_PATH`, and the EDI `converter: URL` contains `user=relative.sef`, then the SEF file will be found at `PRODUCT_PATH/lib/CustomEDI/relative.sef`.

```
try{
    XmlUrlResolver resolver = new XmlUrlResolver();
    Uri sefUri = resolver.ResolveUri(uriBase, "proprietary.sef");

    String ediUri = "converter:EDI:user=" + sefUri;
    Source converterSource = new UriSource(exampleDir + "proprietary.x12");
    Result converterResult = new UriResult("proprietary.xml");
    Converter toXml = factory.CreateConvertToXml(ediUri);
    toXml.Convert(converterSource, converterResult);
    Console.WriteLine("test 7 toXML finished: proprietary.x12 ->
        proprietary.xml");
}
catch (Exception e)
{
    Console.WriteLine("test 7 toXML failed with exception: " + e);
}
```

Example 8

This example shows how to register a `ConverterListener`, which is notified of warnings, errors, and fatal errors that occur during conversion. Also included in this example is a simple implementation of the three `ConverterListener` methods (`warning`, `error`, and `fatalError`). This implementation appears at the end of `demo.cs`.

This example uses the proprietary data file (`proprietary.xml`) as [“Example 7” on page 53](#), but it omits the `proprietary.sef` extension file. This will result in a error that is reported to the `ConverterListener` implementation.

Sample Application

```
try{
    Source converterSource = new UriSource(exampleDir + "proprietary.x12");
    Result converterResult = new UriResult("proprietary.xml");
    Converter toXml = factory.CreateConvertToXml("converter:EDI");

    ConverterListener listener = new DemoListener();
    toXml.Configuration.ConverterListener = listener;
    toXml.Convert(converterSource, converterResult);
    Console.WriteLine("test 8 toXML finished: proprietary.x12 ->
        proprietary.xml");
}
catch (Exception e)
{
    Console.WriteLine("test 8 toXML failed with exception: " + e);
}
```

ConverterListener Implementation in demo.cs

```
public class DemoListener : ConverterListener {  
  
    public void Warning(ConverterException e) {  
        Console.WriteLine("Converter warning notification: " + e);  
  
        return;  
    }  
  
    public void Error(ConverterException e) {  
        Console.WriteLine("Converter error notification: " + e);  
  
        return;  
    }  
  
    public void FatalError(ConverterException e) {  
        Console.WriteLine("Converter fatal error notification: " + e);  
  
        return;  
    }  
}
```

Error Listener Output

After running demo.cs, the program generates the following output; note the error encountered after completing Example 7.

```
test 1 finished: one.csv -> one.xml  
test 2 finished: two.xml -> two.csv  
test 3 finished: three.txt -> three.xml  
test 4 finished: one.csv -> four.xml  
test 5 finished: two.xml -> five.csv  
test 6 toXML finished: 831.x12 -> 831.x12.xml  
test 6 fromXML finished: 831.x12.xml -> 831.x12.fromxml  
test 7 toXML finished: proprietary.x12 -> proprietary.xml  
Converter warning notification:
```

```
com.ddtek.xmlconverter.adapter.edi.EDIConverterException:
[EDI63] WARNING Starting with 00402, ISA11 went from I10 to I65. Replacing
'U' with '^'
for repeat character.
Converter error notification:
com.ddtek.xmlconverter.adapter.edi.EDIConverterException:
[EDI8] ERROR Value 99 not in codelist 353
  Dialect: X12
  Version: syntax=00403/004030;message=00403/004030;agency=004030;table=
          004030
  Message: 831
  Segment: BGN (line 4)
  Position: BGN01
  Element: 353 (s) Transaction Set Purpose Code
  Value: "99"
test 8 toXML finished: proprietary.x12 -> proprietary.xml
test 9 schema generator finished: one.csv -> one.xsd
test 10 schema generator finished: --> edi.xsd
```

Example 9

This example shows how to use the DataDirect XML Converters™ API to create an XML Schema based on a comma-separated values (CSV) file. Note that an instance document is required in order to generate XML Schema for CSV and other file types. See [“Instance Documents” on page 26](#) for more information.

The XML Schema generator is used very much like an XML Converter – the program provides the sample input file as a `Source` object and the generated XML Schema is written to the `Result` object.

See [“XML Schema Generation” on page 23](#) for more information on this topic.

```
try{
    Source sampleSource = new UriSource(exampleDir + "one.csv");
    Result xsdResult     = new UriResult("one.xsd");
    SchemaGenerator generator =
        factory.CreateSchemaGenerator("converter:///CSV:sep=,:first=yes");
    generator.GetSchema(sampleSource, xsdResult);
    Console.WriteLine("test 9 schema generator finished: one.csv -> one.xsd");
}
catch (Exception e)
{
    Console.WriteLine("test 9 schema generator failed with exception: " + e);
}
```

Example 10

This example shows how to use the DataDirect XML Converters™ API to create an XML Schema based on an EDI file. The generated XML Schema depends on the EDI dialect, version, and message being converted, but not on the actual data in the EDI message. This information can be provided

- Using a sample EDI input (as shown in [“Example 9” on page 57](#)). See [“Instance Documents” on page 26](#) for more information.
- As part of the `converter: URL`, as demonstrated in this example. Also, see [“URI Parameters That Affect XML Schema” on page 26](#) for more information.

See [“XML Schema Generation” on page 23](#) for more information on this topic.

```
try{
    Result xsdResult    = new UriResult("edi.xsd");
    String uri = "EDI:dialect=EDIFACT:version=D06B:message=INVOIC:tbl=no";
    SchemaGenerator generator = factory.CreateSchemaGenerator(uri);
    generator.GetSchema(xsdResult);
    Console.WriteLine("test 10 schema generator finished: --> edi.xsd");
}
catch (Exception e)
{
    Console.WriteLine("test 10 schema generator failed with exception: " + e);
}
```

4 XML Converters™ Properties

XML Converters share certain properties (the line separator property, for example), and each has properties that are unique – the CSV XML Converter allows you to specify an escape character, but the binary XML Converter does not, for example.

This chapter provides reference information for the line separator property, which is common to most XML Converters, and reference information for individual XML Converters.

- [“Line Separator Values” on page 60](#)
- [“Base-64 XML Converter Properties” on page 61](#)
- [“Binary XML Converter Properties” on page 62](#)
- [“Comma-Separated Values \(CSV\) XML Converter Properties” on page 63](#)
- [“dBase XML Converter Properties” on page 65](#)
- [“DIF XML Converter Properties” on page 67](#)
- [“EDI XML Converter Properties” on page 68](#)
- [“E-mail Mbox XML Converter Properties” on page 90](#)
- [“HTML Converter Properties” on page 91](#)
- [“Java .properties File XML Converter Properties” on page 92](#)
- [“JSON XML Converter Properties” on page 93](#)
- [“OpenEdge .d Data Dump XML Converter Properties” on page 94](#)
- [“Pyx Format XML Converter Properties” on page 95](#)
- [“Rich Text Format XML Converter Properties” on page 96](#)

- [“SDI XML Converter Properties” on page 97](#)
- [“SYLK XML Converter Properties” on page 98](#)
- [“Tab-Separated Values XML Converter Properties” on page 99](#)
- [“Whole-line Text XML Converter Properties” on page 101](#)
- [“Windows .ini File XML Converter Properties” on page 102](#)
- [“Windows Write XML Converter Properties” on page 103](#)

Line Separator Values

Most XML Converters allow you to specify some type of line separator (referred to in the converter URL as *newline*). The following table summarizes commonly occurring values. All values are case-insensitive.

Table 4-1. Line Separator Values

Value	Description
cr or mac	The Macintosh standard.
lf or unix	The Unix standard.
crlf or dos	The DOS and Windows standard.
lfcr	Not standard usage.
nel	0x85 (commonly found in mainframes).
null	A null byte.
platform	If another value has not been specified, the line separator uses the platform value as returned by the <code>System.getProperty("line.separator")</code> method.

Base-64 XML Converter Properties

The following table shows XML Converters properties for Base-64 encoded binary files as documented in RFC 1341.

XML Converter Name in URL

Base-64

Table 4-2. Properties for Base-64 XML Converters

Property Name	Name in URL	Description
Line separator	newline	Used only when converting a Base-64 binary file to XML, and not vice versa. The default is crlf. See "Line Separator Values" on page 60 for a list of values.
Encoding	encoding	The encoding for the input file when it is not XML; or the encoding for the output file when it is not XML. The default is utf-8.

Binary XML Converter Properties

You can convert binary files that have been encoded as a sequence of digits in a base from 2 to 36, and vice versa. Use the Base-64 XML Converter for base-64 encoded binary files. See [“Base-64 XML Converter Properties”](#) on page 61 for more information.

XML Converter Name in URL

Binary

Table 4-3. Properties for Binary Base-2 to Base-36 XML Converters

Property Name	Name in URL	Description
Line separator	newline	Used when converting a binary encoded file to XML, and vice versa. The default is <code>crlf</code> . See “Line Separator Values” on page 60 for a list of values.
Encoding	encoding	The encoding for the input file when it is not XML; or the encoding for the output file when it is not XML. The default is <code>utf-8</code> .
Base	base	The numeric base of the encoded file. The default is 16 (hexadecimal). Base-2 is binary; base-8 is octal; and base-10 is decimal.
Wrap lines	wrap	Whether you want to wrap lines (<code>wrap=yes</code>) or output all values on a single line (<code>wrap=no</code>).
Byte separator	space	Whether or not byte values should be contiguous (no value) or separated with the value specified for this property. For example, if you set <code>space=,</code> , the value <code>000FFF</code> would be output as <code>00,0F,FF</code> .

Comma-Separated Values (CSV) XML Converter Properties

You can use the CSV XML Converter to convert comma-separated values files to XML and vice versa.

XML Converter Name in URL

CSV (comma-separated values)

Table 4-4. Properties for CSV XML Converters

Property Name	Name in URL	Description
Line separator	newline	See “Line Separator Values” on page 60 for a list of values.
Encoding	encoding	The encoding for the input file when it is not XML; or the encoding for the output file when it is not XML.
Separator	sep	The separator value between each value. This can be 'TAB', any single character (a comma (,) is the default), or the %XX-escaped value of the separator character (%2c, for example).
First row contains field names	first	Generated field names depend on the values in the first and number fields. If <code>first=yes</code> and <code>number=no</code> , field names are read from the first row. Any field names after that are named <code>column.nnn</code> , where <code>nnn</code> is the column number, starting from one and including explicitly named columns in the count. If <code>number=yes</code> , extra columns (those after the first) are named just <code>column</code> .
Escape character	escape	This character escapes quotes and separators so that they can be embedded in values. The back slash (\) is the default.

Table 4-4. Properties for CSV XML Converters

Property Name	Name in URL	Description
Quote character	quotes	A list of characters the converter should interpret as quotation characters. Double and single quote marks (" ') are the default values.
Number rows and columns	number	If <code>number=yes</code> (<code>no</code> is the default), each row will also have an attribute, named <code>row</code> , which will contain the row number from the source document, starting from one. Also, each column, even those explicitly named, will have a column attribute numbering the column from one. Any empty columns are omitted from the output, but the numbering of subsequent columns will reflect that a column(s) was skipped.
Collapse consecutive separators	collapse	Whether or not you want to collapse consecutive separators – that is, separators that do not contain any data. Default is <code>no</code> .
Doubling embedded quote escapes it	double	Whether or not doubling an embedded quotation mark has the effect of escaping the quoted string. Default is <code>no</code> .
Root element name	root	The value you want to use for the root element name. Default is <code>table</code> .
Row element name	row	The value you want to use for the row element name. Default is <code>row</code> .

dBase XML Converter Properties

Properties are the same for all dBase XML Converters – dBase II, dBase III, dBase III+, dBase IV, and dBase V.

XML Converter Names in URL

- dBase_II
- dBase_III
- dBase_III_plus
- dBase_IV
- dBase_V

Table 4-5. Properties for dBase XML Converters

Property Name	Name in URL	Description
Line separator	newline	Used only to convert a dBase file to XML, not vice versa. See "Line Separator Values" on page 60 for a list of values.
Encoding	encoding	The encoding for the input file when it is not XML; or the encoding for the output file when it is not XML. The default is utf-8.
Include deleted records	deleted	Whether or not records marked with a "deleted" attribute are included in the output to XML and preserved in the conversion from XML. Stylus Studio generates the "deleted" attribute on output, and looks for it on input when this property is set to yes.

Datatypes Supported by Version

The following table identifies datatypes supported by dBase XML Converters.

Table 4-6. Datatype Support for dBase XML Converters

<i>Datatype</i>	<i>Symbol</i>	<i>dBase II</i>	<i>dBase III</i>	<i>dBase III+ Plus</i>	<i>dBase IV</i>	<i>dBase V</i>
binary	B					✓
character	C	✓	✓	✓	✓	✓
date	D		✓	✓	✓	✓
float	F				✓	✓
general	G					✓
logical	L	✓	✓	✓	✓	✓
memo	M		✓	✓	✓	✓
numeric	N	✓	✓	✓	✓	✓

DIF XML Converter Properties

You can use the Data Interchange Format (DIF) XML Converter to convert DIF files to XML and vice versa.

XML Converter Name in URL

DIF (Data Interchange Format)

Table 4-7. Properties for the DIF XML Converter

<i>Property Name</i>	<i>Name in URL</i>	<i>Description</i>
Line separator	newline	Used when converting a DIF file to XML, and vice versa. The default is crlf. See “Line Separator Values” on page 60 for a list of values.
Encoding	encoding	The encoding for the input file when it is not XML; or the encoding for the output file when it is not XML. The default is cp850.

EDI XML Converter Properties

Properties are the same for XML Converters for all supported EDI dialects – EANCOM, EDIFACT, HL7, IATA, and X12.

TIP: DataDirect XML Converters also support the Standard Exchange Format (SEF) standard, which allows you to define custom EDI message types. See [“Handling Proprietary EDI Formats” on page 20](#) for more information.

XML Converter Name in URL

EDI

Properties for All EDI XML Converters

The following table describes properties for all EDI XML Converters, regardless of the EDI dialect. See [“Properties for HL7 EDI XML Converters” on page 80](#) for information for properties peculiar to the HL7 dialect.

Table 4-8. Properties for All EDI XML Converters

Property Name	Name in URL	Description
Line separator	newline	Used when converting EDI to XML, and XML to EDI when the <i>Add linefeeds between segments on write</i> property (eo1) is set to yes. The default is crlf. See “Line Separator Values” on page 60 for a list of values.
Encoding	encoding	The encoding for the input file when it is not XML; or the encoding for the output file when it is not XML. The default is utf-8.

Table 4-8. Properties for All EDI XML Converters

Property Name	Name in URL	Description
EDI dialect	dialect	<p>The EDI dialect of the file you are converting. Valid values are: EANCOM, EDIFACT, HL7, IATA, and X12.</p> <p>This property is used only for schema generation. See Chapter 3 "Generating XML Schema" for more information.</p>
Dialect version	version	<p>The version of the dialect specified by the dialect property. Valid values vary based on dialect.</p> <p>This property is used only for schema generation. See Chapter 3 "Generating XML Schema" for more information.</p>
Message type	message	<p>The type of EDI message being converted. Valid values vary based on dialect and version.</p> <p>This property is used only for schema generation. See Chapter 3 "Generating XML Schema" for more information.</p>
Interactive messages	inter	<p>Whether you want the XML Converters to display error messages interactively (as they occur) or to batch all messages. Valid values are yes (display messages interactively) and no (batch messages for display; this is the default).</p> <p>NOTE: This property applies only when using XML Converters to generate XML Schema. See Chapter 3, "Generating XML Schema."</p>
Include xs:documentation	doc	<p>Whether or not include xs:documentation comments in the XML Schema. Valid values are yes (the default) and no.</p> <p>This property is used only for schema generation. See Chapter 3 "Generating XML Schema" for more information.</p>
Extension map file	user	<p>The URL of the SEF file containing custom message type definitions.</p>

Table 4-8. Properties for All EDI XML Converters

Property Name	Name in URL	Description
Enable validation	val	<p>Validates the XML against the structure in the relevant EDI dictionary. An error is generated if the EDI dialect (EDIFACT, X12, for example) isn't recognized; an error is also generated if the dialect is recognized, but the message type isn't. Missing mandatory segments, or segments not specified for a particular group will also generate errors.</p> <p>Consider leaving this option on (<i>yes</i>, the default). If this option is off (<i>no</i>), the converter is not always able to synchronize its position within the EDI dictionary, preventing nested loops from being generated with the output. When possible, leave this property set to <i>yes</i> and ensure that the EDI input conforms to the specification.</p>
Comment code list data	decode	<p>Adds to each code that is looked up in a table a comment that explains the code's value. For example, <code><!--Production Data--></code> in the following code:</p> <pre><ISA15><!--I14: Interchange Usage Indicator-->P<!--Production Data--></ISA15></pre> <p>Turn off this and <i>Comment element types</i> (<code>field</code>) to disable all comment generation.</p>
Comment element types	field	<p>Creates a comment at the start of each element that includes the element's name and number. For example, <code><!--I14: Interchange Usage Indicator--></code> in the following code:</p> <pre><ISA15><!--I14: Interchange Usage Indicator-->P<!--Production Data--></ISA15></pre> <p>Turn off this and <i>Comment code list</i> (<code>decode</code>) to disable all comment generation.</p>
Strict validation on value lengths	len	<p>Checks each value against the upper and lower length limits defined in the EDI specification.</p>

Table 4-8. Properties for All EDI XML Converters

Property Name	Name in URL	Description
Strict segment-ordering checking	seg	Relaxes the rules that require that segments come in the specified order. However, if this property is off (no), some looping constructs might break, resulting in data being grouped in correctly.
Enforce segment maximum counts	count	Whether or not you want XML Converters to enforce segment counts as they are defined in the EDI repository. Valid values are: <ul style="list-style-type: none"> ■ yes – Repository counts are enforced. ■ no – Repository counts are not enforced. ■ multi – If the repository allows only one instance, enforce it; otherwise, treat the count as unlimited. <p>See also “auto” on page 74.</p>
Force error if value not in code list	tbl	Generates an error if the value for an element is not in the codelist associated with that element. If this property is off (no), values are not checked for the presence of a codelist.
Strict datatype content checking	typ	Ensures that only characters that are appropriate for a given field are included in the value for that field. For example, this property ensures that dates are valid and numbers are well-formed.
Strip C-style comments	strip	Determines whether content in the incoming EDI stream wrapped in C-style /* and */ comment delimiters is ignored. Default setting is off (strip=no) since it can potentially conflict with real EDI content. HL7 files used with or generated by certain systems might include this markup, for example.

Table 4-8. Properties for All EDI XML Converters

Property Name	Name in URL	Description
Character repertoire override	chr	<p>Allows XML Converters to override and alter character encodings for EDIFACT-based documents (like EANCOM and IATA).</p> <p>You can use one or more of the following options, connected with a "+" symbol (chr=REPLACE+FINNISH, for example):</p> <ul style="list-style-type: none"> ■ DEFAULT – The encoding specified in the file is used. This option cannot be used with any others. ■ EANCOM – Support for these extra EANCOM characters to UNOA and UNOB are added: #, @, [,], {, }, \, , ', and ^. ■ SYMBOL – Forces all characters, including special characters such as element and segment separators that might otherwise be permitted, to be validated against the encoding. ■ REPLACE – Replaces any invalid characters with the character specified by the invalid property. An underscore ("_") is used if the invalid property is not specified. If REPLACE is not specified, XML Converters throws an error. ■ FINNISH – Changes the meaning of certain characters in the Finnish character set for UNOA and UNOB (and adds UNOY and UNOZ as synonyms for UNOA and UNOB respectively). <p>See "FINNISH Character Set Overrides" on page 77 for more information.</p> <p>See "Explicit Character Overrides" on page 78 for more information on this topic.</p>

Table 4-8. Properties for All EDI XML Converters

Property Name	Name in URL	Description
Invalid character replacement	invalid	<p>Used with REPLACE value for the <code>chr</code> property to specify the character that should be used to replace invalid characters. The default (if <code>invalid</code> is not specified) is an underscore ("<code>_</code>"). Valid values are:</p> <ul style="list-style-type: none"> ■ <code>\u####</code> – To specify a Unicode value, substituting the <code>####</code> for the appropriate value. ■ <code>\d####</code> – To specify a decimal value, substituting the <code>####</code> for the appropriate value. <p>See “Using Special Characters for Separators” on page 83 for more information about how to specify values for this property.</p>
Treat all segments as optional	opt	<p>If set to <code>yes</code> (<code>no</code> is the default), Stylus Studio assumes that all segments are optional. This property can be useful if your provider declines to provide segments that are considered mandatory according to the EDI specification, but you are aware of what the missing values are.</p> <p>This property is not used if <code>Enable validation (val)</code> is set to <code>yes</code>.</p>
Add linefeeds between segments on write	eol	<p>Allows you to put each segment on its own line when converting XML to EDI. (Extra linefeeds are ignored when converting EDI to XML.) If this property is set to <code>yes</code> (the default), the value specified in the Line separator (<code>newline</code>) property is used to separate each segment. The normal segment output character is also generated.</p>

Table 4-8. Properties for All EDI XML Converters

Property Name	Name in URL	Description
Auto-fixup values where possible	auto	<p>Automatically calculates values where possible.</p> <p>For X12, it counts segments and fills in hash values for CTT, SE and IEA segments.</p> <p>For EDIFACT, it does segment totals for UNE, UNT, and UNZ segments. If the UNZ segment is missing, it is created as needed.</p> <p>The SE or UNT segments only need to be mapped; all of their elements can be automatically populated.</p> <p>In any header or trailer fields where there are dates or times, segments are placed into the correct format based on whether they are defined as YYMMDD or CCYYMMDD for dates, or whatever length for times. Default values will be filled in if they are missing.</p> <p>See also “count” on page 71.</p>
Strict validation mode	strict	<p>Checks that all mandatory elements are present, and ensures that no composite elements are in places where only simple elements are allowed. Also checks for extra elements at the end of segments that are not part of the specification.</p>
Remove linefeeds and nulls	clean	<p>Whether or not you want to remove linefeeds and nulls from EDI converted to XML and vice versa. Valid values are both (directions), fromXML, toXML, and never.</p> <p>See also “rtrim” on page 77.</p>
Window for century cut-off	cent	<p>If the date is given in the file with a two-digit year and the output requires a four-digit year, this value is the cutoff so that the proper century can be selected.</p>

Table 4-8. Properties for All EDI XML Converters

Property Name	Name in URL	Description
Ignore leading zeros on numbers	ignore	Whether or not you want the XML Converter engine to ignore leading zeros on numbers. Setting <code>ignore=yes</code> means that leading zeros on the value in the EDI and the value in the codelist are compared without any leading zeros. So with <code>ignore=no</code> , "012" does not match "12"; but with <code>ignore=yes</code> these values do match. This applies only to codelist validation, not for handling of numbers.
Namespace prefix	prefix	Namespace prefix to be added, with the Namespace URI, to the root element. The prefix alone is added to all elements.
Namespace URI	uri	Namespace URI to be added, with the Namespace prefix, to the root element. If the prefix is set, but the URI is not, the prefix is ignored.
Use long element names	long	Whether you want to use long or short element names in your XML conversions – FTX03-TextReference (long) or FTX03 (short), for example.
Use message groups if provided	group	Adds an extra <code><GROUP></GROUP></code> around a message group in the output XML to make message groupings easier to handle with XPath for some types of documents. If you use multiple message groups within a single EDI document, turning this on may make selecting the messages within a specific group easier.
Write setup segment if appropriate	setup	Used to indicate whether or not to write the file's setup segment when writing EDI. Used only if the EDI dialect supports an optional setup segment (the EDIFACT or IATA UNA segment, for example); otherwise, it is ignored. Valid values are <code>yes</code> and <code>no</code> ; the default is <code>yes</code> .

Table 4-8. Properties for All EDI XML Converters

Property Name	Name in URL	Description
Segment separator	segment	The character you want to use for segment separators. See “Using Special Characters for Separators” on page 83 for information about how to specify values for this property.
Element separator	element	The character used to separate elements in a segment. See “Using Special Characters for Separators” on page 83 for information about how to specify values for this property.
Component value separator	component	When an element is a composite element, the character that is used to separate the component elements from each other within the composite element. See “Using Special Characters for Separators” on page 83 for information about how to specify values for this property.
Release (escape) symbol	release	The release, or escape, character. It turns off special processing of the next character. Suppose your message uses within a text description the same character that was used to separate elements. This is the character that would be used to tell the EDI processor to treat that character as a normal character and not as the end of the text. See “Using Special Characters for Separators” on page 83 for information about how to specify values for this property.
Decimal character	decimal	Symbol used for the decimal character in the converted file. Usually a period or comma. See “Using Special Characters for Separators” on page 83 for information about how to specify values for this property.
Subcomponent (tertiary) separator	tertiary	The character you want to use for subcomponent separators. See “Using Special Characters for Separators” on page 83 for information about how to specify values for this property.

Table 4-8. Properties for All EDI XML Converters

Property Name	Name in URL	Description
Repeat symbol	repeat	The repeat symbol for EDI dialects that use it. See “Using Special Characters for Separators” on page 83 for information about how to specify values for this property.
Trim trailing delimiters	rtrim	Typically, most trailing delimiters are removed automatically. But in the conversion process, new trailing delimiters are sometimes created. The <code>rtrim</code> property controls how XML Converters manages these trailing delimiters. Valid values are: <ul style="list-style-type: none"> ■ <code>no</code> – Trailing delimiters are not trimmed. ■ <code>yes</code> – Trailing delimiters are trimmed as long as performance is not affected. ■ <code>always</code> – Trailing delimiters are trimmed regardless of the impact on performance. See also “clean” on page 74.

FINNISH Character Set Overrides

As described elsewhere, you can use the using the [Character repertoire override](#) property (`chr`) to change the meaning of certain characters for the Finnish character set for UNOA (UNOY) and

UNOB (UNOZ). The following table shows which characters are changed based on the character set in use.

Table 4-9. Character Encoding Overrides

Character From	Character To	Applicable Character Sets	Unicode Name
[Ä	UNOA/UNOY, UNOB/UNOZ	Latin capital letter A with diaeresis
\	Ö	UNOA/UNOY, UNOB/UNOZ	Latin capital letter O with diaeresis
]	Å	UNOA/UNOY, UNOB/UNOZ	Latin capital letter A with ring above
^	Ü	UNOA/UNOY, UNOB/UNOZ	Latin capital letter U with diaeresis
{	ä	UNOB/UNOZ	Latin small letter a with diaeresis
	ö	UNOB/UNOZ	Latin small letter o with diaeresis
}	å	UNOB/UNOZ	Latin small letter a with ring above
~	ü	UNOB/UNOZ	Latin small letter u with diaeresis

Explicit Character Overrides

In addition to the modifiers you can specify using the [Character repertoire override](#) property (`chr`), you can instruct the XML Converters to take character encodings from the URI, instead of from the EDIFACT-style UNB or UIB 001 element. If you choose to

do this, you may use the encodings described in the following table:

Table 4-10. Character Encoding Overrides

<i>Property Name</i>	<i>Description</i>
UNOA or IATA	UN/ECE level A (upper case only)
UNOB or IATA	UN/ECE level B (same as UNOA but including lower case)
UNOC or IATC	UN/ECE level C (ISO-8859-1 or Latin-1/Western European)
UNOD or IATD	UN/ECE level D (ISO-8859-2 or Latin-2/Central European)
UNOE or IATE	UN/ECE level E (ISO-8859-5 or Latin/Cyrillic)
UNOF or IATF	UN/ECE level F (ISO-8859-7 or Latin/Greek)
UNOG or IATG	UN/ECE level G (ISO-8859-3 or Latin-3/South European)
UNOH or IATH	UN/ECE level H (ISO-8859-4 or Latin-4/North European)
UNOI or IATI	UN/ECE level I (ISO-8859-6 or Latin/Arabic)
UNOJ or IATJ	UN/ECE level J (ISO-8859-8 or Latin/Hebrew)
UNOK or IATK	UN/ECE level K (ISO-8859-9 or Latin-5/Turkish)
UNOQ or IATQ	UN/ECE level Q (ISO-8859-15 or Latin-9/)
UNOW or IATW	UN/ECE level W (ISO 10646-1 octet with code extension technique to support UTF-8)
UNOX or IATX	UN/ECE level X (Code extension technique as defined by ISO 2022 utilizing the escape techniques in accordance with ISO 2375)
UNOY or IATY	UN/ECE level Y (ISO 10646-1 octet without code extension technique.); also Finnish UNOA
UNOZ or IATZ	Finnish UNOB

These can also be combined with other `chr=` options. For example, an EDI file might specify UNOA encoding, but with lower-case text, because the sending system sent inconsistent data. Using `chr=UNOB+REPLACE`, the data could be consumed, and any non-UNOB characters would turn into '_' characters, allowing processing to continue.

XML Converters does no character checking for UNOX; rather it depends on the native platform converter or the application to ensure that the characters are valid. This is because there are too many implementation-specific details, subsets, and proprietary and local extensions, and it is not possible to account for them all.

Properties for HL7 EDI XML Converters

The following table describes properties that are specific to the EDI XML Converters used with the HL7 dialect.

Table 4-11. Properties for HL7 EDI XML Converters

Property Name	Name in URL	Description
Expand hex escapes	hexand	In HL7 data streams, \x is an escape sequence used to include hex data in the stream. You can use the <code>hexand</code> option (<code>hexand=yes</code>) to expand the hex data. If the data is binary, an exception is thrown. Valid values are <code>yes</code> and <code>no</code> .
Expand composite elements	cexpand	HL7 includes specialized composite elements that contain coded values, the text version of the code, and the lookup table for CE, CF, CNE, and CWE elements. If you set <code>cexpand=yes</code> , XML Converters attempts to expand all of the fields in the composite element. The CNE and CWE elements also allow pulling information from tables across versions of the standard – an HL7 2.4 element could look up information from an HL7 2.5 table, for example. Each of these also has an ‘alternate’ set of fields, so that codes can be included both in the native (HL7, for example) and foreign code list.

Table 4-11. Properties for HL7 EDI XML Converters

<i>Property Name</i>	<i>Name in URL</i>	<i>Description</i>
Local date handling	ldate	<p>Controls how XML Converters manages the <i>L</i> value (which traditionally means "local system" in HL7) if it is passed as either a date, time, datetime, or timestamp. Valid values are:</p> <ul style="list-style-type: none"> ■ header – The <i>L</i> value is replaced with the value of the MSH-7 element from the header. ■ current – The <i>L</i> value is replaced with the date and/or time that the message processing started. ■ error – The <i>L</i> value is treated as a syntax error. ■ pass – The <i>L</i> value is passed through unchanged.

Table 4-11. Properties for HL7 EDI XML Converters

Property Name	Name in URL	Description
Empty content handling	empty	<p>Controls how XML Converters manages empty fields. In HL7 versions prior to 2.3, empty fields were treated as present, but without a value; in HL7 version 2.3 and later, empty fields are indicated with a set of quotation marks. A missing field – that is, a field for which there is no value in the data stream – does not display quotation marks. Valid values are:</p> <ul style="list-style-type: none"> ■ auto – The HL7 version determines how XML Converters treats empty fields: <ul style="list-style-type: none"> ■ HL7 2.2 and earlier – XML Converters behaves as if empty=empty. ■ HL7 2.3 and later – XML Converters behaves as if empty=quotes. ■ empty – All empty fields, with or without quotation marks, are treated as present but empty (HL7 2.2 and earlier). ■ quotes – If the field has quotes, it is treated as empty (the data stream has a null value); otherwise, it is treated as missing (there is no value in the data stream) (HL7 2.3 and later).

Using Special Characters for Separators

Most special characters or symbols cannot be entered directly into a URL – you cannot specify that the colon (:) is the element separator character by entering `converter:EDI:element=: :auto=yes`, for example. Instead, you must escape special characters using the appropriate decimal or hex value. To specify a colon as a element separator character, you would use `converter:EDI:element=\u003A:auto=yes`, for example. Note that not all EDI dialects use all special characters.

See [Table 4-12, “Common Separator Characters,” on page 84](#) for a complete list of separator characters and their decimal and hex values.

Which Properties Specify Separators?

The following properties can be used to specify separators for EDI XML Converters:

- [“segment”](#) on page 76
- [“element”](#) on page 76
- [“component”](#) on page 76
- [“release”](#) on page 76
- [“decimal”](#) on page 76
- [“tertiary”](#) on page 76
- [“repeat”](#) on page 77.

Restrictions for Separator Characters

The values you set for separator properties apply only when converting XML to EDI.

You cannot use letters, numbers, or spaces for separator characters.

You must use unique values for each separator property you choose to set.

Commonly Used Separator Characters

Commonly used separator characters and their escape values (in decimal and hex) are shown in the following table.

Table 4-12. Common Separator Characters

Character	Decimal	Hex
~	\d126	\u007E
!	\d33	\u0021
@	\d64	\u0040
#	\d35	\u0023
\$	\d36	\u0024
%	\d37	\u0025
^	\d94	\u005E
&	\d38	\u0026
*	\d42	\u002A
(\d40	\u0028
)	\d41	\u0029
_	\d95	\u005F
+	\d43	\u002B
`	\d96	\u0060
-	\d45	\u002D

Table 4-12. Common Separator Characters

Character	Decimal	Hex
=	\d61	\u003D
[\d91	\u005B
]	\d93	\u005D
}	\d123	\u007B
{	\d125	\u007D
\	\d92	\u005C
	\d124	\u007C
'	\d39	\u0027
;	\d59	\u003B
"	\d34	\u0022
:	\d58	\u003A
/	\d47	\u002F
.	\d46	\u002E
,	\d44	\u002C
?	\d63	\u003F
>	\d62	\u003E
<	\d60	\u003C

Control Characters

You can also use non-printable control characters as separators, as shown in the following table.

Table 4-13. Control Characters

Character	Decimal	Hex	Other
NUL	\d0	\u0000	
SOH	\d1	\u0001	
STX	\d2	\u0002	

Table 4-13. Control Characters

Character	Decimal	Hex	Other
ETX	\d3	\u0003	
EOT	\d4	\u0004	
ENQ	\d5	\u0005	
ACK	\d6	\u0006	
BEL	\d7	\u0007	
BELL	\d7	\u7000	
BS	\d8	\u0008	
HT	\d9	\u0009	\t
TAB	\d9	\u0009	\t
LF	\d10	\u000A	\n
VT	\d11	\u000B	
FF	\d12	\u000C	\f
CR	\d13	\u000D	\r
SO	\d14	\u000E	
SI	\d15	\u000F	
DLE	\d16	\u0010	
DC1 (XON)	\d17	\u0011	
DC2	\d18	\u0012	
DC3 (XOFF)	\d19	\u0013	
DC4	\d10	\u0014	
NAK	\d21	\u0015	
SYN	\d22	\u0016	
ETB	\d23	\u0017	
CAN	\d24	\u0017	
EM	\d25	\u0019	
SUB	\d26	\u001a	
ESC	\d27	\u001b	
FS	\d28	\u001c	
GS	\d29	\u001d	

Table 4-13. Control Characters

Character	Decimal	Hex	Other
RS	\d30	\u001e	
US	\d31	\u001f	
DEL	\d127	\u007F	
BPH	\d130	\u0082	
NBH	\d131	\u0083	
IND	\d132	\u0084	
NEL	\d133	\u0085	
SSA	\d134	\u0086	
ESA	\d135	\u0087	
HTS	\d136	\u0088	
HTJ	\d137	\u0089	
VTS	\d138	\u008A	
PLD	\d139	\u008B	
PLU	\d140	\u008C	
RI	\d141	\u008D	
SS2	\d142	\u008E	
SS3	\d143	\u008F	
DCS	\d144	\u0090	
PU1	\d145	\u0091	
PU2	\d146	\u0092	
STS	\d147	\u0093	
CCH	\d148	\u0094	
MW	\d149	\u0095	
SPA	\d150	\u0096	
EPA	\d151	\u0097	
SOS	\d152	\u0098	
SCI	\d154	\u009A	
CSI	\d155	\u009B	
ST	\d156	\u009C	

Table 4-13. Control Characters

Character	Decimal	Hex	Other
OSC	\d157	\u009D	
PM	\d158	\u009E	
APC	\d159	\u009F	
NBS (NBSP)	\d160	\u00A0	
SHY	\d173	\u00AD	

EDI Processing Instructions

You can specify EDI processing instruction (PI) values in the EDI XML Converter URL as described in the following table.

Table 4-14. Properties for EDI Processing Instructions

Processing Instruction	Name in URL	Description	Default
edi_segment	segment	Segment separator.	'
edi_element	element	Element separator.	+
edi_component	component	Component value separator.	:
edi_release	release	Release (escape) separator.	?
edi_decimal	decimal	Decimal character.	,
edi_tertiary	tertiary	Subcomponent (tertiary) separator.	&
edi_repeat	repeat	Repeat symbol separator.	~
edi_invalid	invalid		

Leave these values blank to assume the default values. XML Converters will generate an error if a PI and URL switch have conflicting values, or if either value conflicts with one of the values encoded in a segment for these values.

The syntax of an EDI processing instruction is "<?" followed by processing instruction name (edi_segment, for example), followed by a space, and then the new special character.

Example

Suppose an X12 document had to be written so that the segment terminator was a carriage return, the element separator was an asterisk, and the component separator was the greater-than symbol. The actual start of the file might end up looking much like this:

```
<?xml version="1.0" encoding="utf-8"?>
<?edi_segment \r?>
<?edi_element *?>
<X12>
  <ISA>
    <ISA01><!--I01: Authorization Information Qualifier-->00</ISA01>
    <ISA02><!--I02: Authorization Information-->          </ISA02>
    <ISA03><!--I03: Security Information Qualifier-->00</ISA03>
    <ISA04><!--I04: Security Information-->              </ISA04>
    <ISA05><!--I05: Interchange ID Qualifier-->01</ISA05>
    <ISA06><!--I06: Interchange Sender ID-->1515151515   </ISA06>
    <ISA07><!--I05: Interchange ID Qualifier-->01</ISA07>
    <ISA08><!--I07: Interchange Receiver ID-->5151515151  </ISA08>
    <ISA09><!--I08: Interchange Date-->041201<!--2004-12-01--></ISA09>
    <ISA10><!--I09: Interchange Time-->1217</ISA10>
    <ISA11><!--I65: Repetition Separator-->U</ISA11>
    <ISA12><!--I11: Interchange Control Version-->00403</ISA12>
    <ISA13><!--I12: Interchange Control Number-->000032123</ISA13>
    <ISA14><!--I13: Acknowledgment Requested-->0</ISA14>
    <ISA15><!--I14: Usage Indicator-->P</ISA15>
    <ISA16><!--I15: Component Element Separator-->></ISA16>
  </ISA>
  ...

```

E-mail Mbox XML Converter Properties

The E-mail MBox (MBox) XML Converter can be used for MBox-to-XML conversion only. This XML Converter supports MIME attachments – any message attachments are properly decoded and rendered as XML. Specifically:

- Text and plain attachments are embedded as text
- Binary attachments are embedded as hex-encoded data

XML-encoded attachments are emitted as escaped text

XML Converter Name in URL

MBox

Table 4-15. Properties for MBox XML Converters

<i>Property Name</i>	<i>Name in URL</i>	<i>Description</i>
Line separator	newline	Used when converting a file to XML, and vice versa. The default is crlf. See “Line Separator Values” on page 60 for a list of values.
Encoding	encoding	The encoding for the input file when it is not XML; or the encoding for the output file when it is not XML. The default is utf-8.

HTML Converter Properties

You can use the HTML XML Converter to convert HTML to XHTML.

XML Converter Name in URL

HTML

Table 1. Properties for the HTML XML Converter

<i>Property Name</i>	<i>Name in URL</i>	<i>Description</i>
Line separator	newline	Used when converting HTML to XHTML. The default is crlf. See “Line Separator Values” on page 60 for a list of values.
Encoding	encoding	The encoding for the input file when it is not XML; or the encoding for the output file when it is not XML. The default is utf-8.
Abort on warnings found	warnings	Whether or not you want the adapter to fail when it encounters potential problems with the HTML-to-XHTML mapping. <code>warnings=no</code> is the default.
Abort on errors found	errors	Whether or not you want the adapter to fail when it encounters problems with the HTML-to-XHTML mapping. If <code>errors=no</code> , the adapter continues with the conversion, making a best guess. <code>errors=yes</code> is the default.

Java .properties File XML Converter Properties

You can use the JavaProps XML Converter to convert Java .properties files to XML and vice versa.

XML Converter Name in URL

JavaProps

Table 4-16. Properties for JavaProps XML Converters

<i>Property Name</i>	<i>Name in URL</i>	<i>Description</i>
Line separator	newline	Used when converting a file to XML, and vice versa. The default is crlf. See “Line Separator Values” on page 60 for a list of values.
Encoding	encoding	The encoding for the input file when it is not XML; or the encoding for the output file when it is not XML. The default is ISO-8859-1.

JSON XML Converter Properties

The following table shows properties for JSON (JavaScript Object Notation) XML Converters.

XML Converter Name in URL

JSON

Table 4-17. Properties for JSON XML Converters

<i>Property Name</i>	<i>Name in URL</i>	<i>Description</i>
Line separator	newline	The character that indicates the start of a new line in the document to be converted. The default is crlf. See "Line Separator Values" on page 60 for a list of values.
Indent	indent	The level of indent you want to use for the converted XML. The default is 4.

OpenEdge .d Data Dump XML Converter Properties

You can use the DotD XML Converter to convert Progress OpenEdge .d data dump files to XML and vice versa.

XML Converter Name in URL

DotD

Table 4-18. Properties for DotD XML Converters

<i>Property Name</i>	<i>Name in URL</i>	<i>Description</i>
Line separator	newline	Used when converting a file to XML, and vice versa. The default is crlf. See “Line Separator Values” on page 60 for a list of values.
Encoding	encoding	The encoding for the input file when it is not XML; or the encoding for the output file when it is not XML. The default is utf-8.

Pyx Format XML Converter Properties

You can use the Pyx XML Converter to convert Pyx format files to XML and vice versa.

XML Converter Name in URL

Pyx

Table 4-19. Properties for Pyx XML Converters

<i>Property Name</i>	<i>Name in URL</i>	<i>Description</i>
Line separator	newline	Used when converting a file to XML, and vice versa. The default is crlf. See “Line Separator Values” on page 60 for a list of values.
Encoding	encoding	The encoding for the input file when it is not XML; or the encoding for the output file when it is not XML. The default is utf-8.

Rich Text Format XML Converter Properties

XML Converter Name in URL

RTF

Table 4-20. Properties for RTF XML Converters

<i>Property Name</i>	<i>Name in URL</i>	<i>Description</i>
Line separator	newline	Used when converting a file to XML, and vice versa. The default is crlf. See “Line Separator Values” on page 60 for a list of values.
Encoding	encoding	The encoding for the input file when it is not XML; or the encoding for the output file when it is not XML. The default is cp850.

SDI XML Converter Properties

You can use the SDI XML Converter to convert Super Data Interchange Format (SDI) files to XML and vice versa.

XML Converter Name in URL

SDI (Super Data Interchange Format)

Table 4-21. Properties for SDI XML Converters

<i>Property Name</i>	<i>Name in URL</i>	<i>Description</i>
Line separator	newline	Used when converting SDI files to XML, and vice versa. The default is crlf. See “Line Separator Values” on page 60 for a list of values.
Encoding	encoding	The encoding for the input file when it is not XML; or the encoding for the output file when it is not XML. The default is cp850.

SYLK XML Converter Properties

You can use the SYLK XML Converter to convert Symbolic Link Format (SYLK) files to XML and vice versa.

XML Converter Name in URL

SYLK (Symbolic Link Format)

Table 4-22. Properties for SYLK XML Converters

<i>Property Name</i>	<i>Name in URL</i>	<i>Description</i>
Line separator	newline	Used when converting SYLK files to XML, and vice versa. The default is crlf. See “Line Separator Values” on page 60 for a list of values.
Encoding	encoding	The encoding for the input file when it is not XML; or the encoding for the output file when it is not XML. The default is cp850.

Tab-Separated Values XML Converter Properties

You can use the TAB XML Converter to convert tab-separated values files to XML and vice versa.

XML Converter Name in URL

TAB (tab-separated values)

Table 4-23. Properties for Tab-Separated Values XML Converters

<i>Property Name</i>	<i>Name in URL</i>	<i>Description</i>
Line separator	newline	See "Line Separator Values" on page 60 for a list of values.
Encoding	encoding	The encoding for the input file when it is not XML; or the encoding for the output file when it is not XML.
Separator	sep	The separator value between each value. This can be 'TAB', any single character (a comma (,) is the default), or the %XX-escaped value (%2c, for example).
First row contains field names	first	Generated field names depend on the values in the first and number fields. If first=yes and number=no, field names are read from the first row. Any field names after that are named column.nnn, where nnn is the column number, starting from one and including explicitly named columns in the count. If number=yes, extra columns (those after the first) are named just column.
Escape character	escape	This character escapes quotes and separators so that they can be embedded in values. The backslash (\) is the default.

Table 4-23. Properties for Tab-Separated Values XML Converters

Property Name	Name in URL	Description
Quote characters	quotes	A list of characters the converter should interpret as quotation characters. Double and single quote marks (" ') are the default values.
Number rows and columns	number	If number=yes (no is the default), each row will also have an attribute, named row, which will contain the row number from the source document, starting from one. Also, each column, even those explicitly named, will have a column attribute numbering the column from one. Any empty columns are omitted from the output, but the numbering of subsequent columns will reflect that a column(s) was skipped.
Collapse consecutive separators	collapse	Whether or not you want to collapse consecutive separators – that is, separators that do not contain any data. Default is no.
Doubling embedded quote escapes it	double	Whether or not doubling an embedded quotation mark has the effect of escaping the quoted string. Default is no.
Root element name	root	The value you want to use for the root element name. Default is table.
Row element name	row	The value you want to use for the row element name. Default is row.

Whole-line Text XML Converter Properties

You can use the Line XML Converter to convert whole-line text formatted files to XML and vice versa.

XML Converter Name in URL

Line

Table 4-24. Properties for the Whole-line Text XML Converter

<i>Property Name</i>	<i>Name in URL</i>	<i>Description</i>
Line separator	newline	Used when converting a whole-line text file to XML, and vice versa. The default is crlf. See “Line Separator Values” on page 60 for a list of values.
Encoding	encoding	The encoding for the input file when it is not XML; or the encoding for the output file when it is not XML. The default is utf-8.
Root element name	root	Value used for the root element name. Default is root.
Line element name	line	Value used for the line element name. Default is line.

Windows .ini File XML Converter Properties

You can use the WinIni XML Converter to convert Windows .ini files to XML and vice versa.

XML Converter Name in URL

WinIni

Table 4-25. Properties for WinIni XML Converters

<i>Property Name</i>	<i>Name in URL</i>	<i>Description</i>
Line separator	newline	Used when converting a file to XML, and vice versa. The default is crlf. See “Line Separator Values” on page 60 for a list of values.
Encoding	encoding	The encoding for the input file when it is not XML; or the encoding for the output file when it is not XML. The default is cp1252.

Windows Write XML Converter Properties

You can use the WinWrite XML Converter to convert Windows Write files to XML and vice versa.

XML Converter Name in URL

WinWrite

Table 4-26. Properties for WinWrite XML Converters

<i>Property Name</i>	<i>Name in URL</i>	<i>Description</i>
Line separator	newline	Used when converting a file to XML, and vice versa. The default is crlf. See “Line Separator Values” on page 60 for a list of values.
Encoding	encoding	The encoding for the input file when it is not XML; or the encoding for the output file when it is not XML. The default is utf-8.

Index

Symbols

.NET API
namespaces 31

A

accessing data using Stylus Studio URL
schemes 18
API
examples 43
Microsoft Help 2.0 for 31
XML Converters namespaces 31

B

Base-64 XML Converter properties 61
binary XML Converter properties 62

C

command line usage 19
Configuration class description 31
contacting Technical Support 12
control characters
for EDI XML Converters 85
conventions, typographical 11
Conversion class description 32
ConversionStatus class description 32
Converter class description 34

converter URL scheme
building a converter URL 41
description 19
displayed in Stylus Studio 42
parts of 37
syntax of 41
using with user-defined .conv files 39
ConverterFactory class description 32
ConverterResolver class description 32
CSV XML Converter properties 63
custom XML conversions
using with converter URLs 39
customizing file conversions 17

D

data
accessing data using Stylus Studio URL
schemes 18
dBase XML Converter properties 65
DDTek.Xmlconverter namespace 31
demo.cs example 43
DIF XML Converter properties 67
documentation
.NET API
Microsoft Help 2.0 for 31
DocumentResult class description 32
DocumentSource class description 32
DotD XML Converter properties 94

E

- EANCOM files
 - XML Converter properties for 68
- EDI
 - HL7 XML Converter properties 80
- EDI XML Converters
 - exception handling for 22
 - proprietary EDI formats and 20
 - SEF support 20
- EDIFACT files
 - XML Converter properties for 68
- error handling
 - example 54
 - overview 21
- examples 43
 - converting CSV to XML 46
 - converting X12 to XML 52
 - converting XML to CSV 47
 - converting XML to X12 52
 - converting XSLT output to CSV 51
 - creating an XML Schema from a CSV file 57
 - creating an XML Schema from EDI 58
 - demo.cs 43
 - error handling 54
 - streaming XML 49
 - using custom XML conversions 48
 - using SEF to convert EDI 53
- exception handling 22

F

- files
 - customizing file conversions 17
 - formats supported by XML Converters 15
 - generating XML Schema from 30

G

- generating XML Schema
 - example 24, 36
 - file type summary 30
 - instance documents 26
 - overview 23
 - URI parameters 26

H

- HL7 files
 - XML Converter properties for 68
- HL7 XML Converter properties 80
- HTML XML Converter properties 91

I

- IATA files
 - XML Converter properties for 68
- InputStreamResult class description 32
- InputStreamSource class description 32
- instance documents
 - XML Schema generation and 26

J

- JavaProps XML Converter properties 92
- JSON XML Converter properties 93

L

- Line XML Converter properties 101

M

MBox XML Converter properties 90
 Microsoft Help 2.0
 XML Converters API 31

N

namespaces
 summary of XML Converters namespaces
 31

O

OpenEdge DotD XML Converter properties
 94
 OutputStreamResult class description 32
 OutputStreamSource class description 32

P

processing instructions
 for EDI XML Converters 88
 Pyx XML Converter properties 95

R

Result class description 33
 RTF XML Converter properties 96

S

SDI XML Converter properties 97
 SEF
 support in EDI XML Converters 20
 separator characters
 for EDI XML Converters 83
 Source class description 33
 special characters
 for EDI XML Converters 83
 Standard Exchange Format. See SEF
 Stylus Studio
 building a converter URL using 41
 SupportLink 12
 SYLK XML Converter properties 98

T

TAB XML Converter properties 99
 Technical Support, contacting 12
 TextReaderResult class description 33
 TextReaderSource class description 33
 TextWriterResult class description 33
 TextWriterSource class description 33

U

URI parameters
 XML Schema generation and 26
 UriResult class description 33
 UriSource class description 33
 URL schemes
 descriptions of 19
 the `converter` URL scheme 18

W

WinIni XML Converter properties 102
WinWrite XML Converter properties 103

X

X12 files

XML Converter properties for 68

XML Converters

.NET API namespaces 31

Base-64 XML Converter properties 61

binary XML Converter properties 62

building a converter URL using Stylus

Studio 41

command line usage 19

control characters for EDI XML Converters
85

CSV XML Converter properties 63

customizing 17

dBase XML Converter properties 65

descriptions of 15

DIF XML Converter properties 67

DotD XML Converter properties 94

EANCOM file converter properties 68

EDIFACT file converter properties 68

error handling 21

examples 43

exception handling 22

file formats supported by 15

generating XML Schema with 23, 24

HL7 file converter properties 68

HTML XML Converter properties 91

IATA file converter properties 68

JavaProps XML Converter properties 92

JSON XML Converter properties 93

line separator values used in 60

Line XML Converter properties 101

MBox XML Converter properties 90

OpenEdge DotD XML Converter
properties 94

overview 15

processing instructions for EDI XML
Converters 88

Pyx XML Converter properties 95

RTF XML Converter properties 96

SDI XML Converter properties 97

SEF support 20

separator characters for EDI XML
Converters 83

special characters for EDI XML Converters
83

SYLK XML Converter properties 98

TAB XML Converter properties 99

WinIni XML Converter properties 102

WinWrite XML Converter properties 103

X12 file converter properties 68

XML Schema

example of generating 36

generating

example 24

instance documents 26

overview 23

URI parameters 26

generation

file type summary 30

XML Schema generation

example 36

instance documents and 26

URI parameters and 26

XmlReaderResult class description 33

XmlReaderSource class description 33

XmlWriterResult class description 34

XmlWriterSource class description 34